

# Control Link ACC

*Anti-Condensate Controller System Installation and Operation*



Copeland  
1065 Big Shanty Road NW, Suite 100  
Kennesaw, GA 30144 USA  
770-425-2724 • 1-800-829-2724  
[www.copeland.com](http://www.copeland.com)  
*Email:* [ColdChain.TechnicalServices@copeland.com](mailto:ColdChain.TechnicalServices@copeland.com)

**1 OVERVIEW ..... 1**

**2 COMPONENTS ..... 1**

2.1 Control Link ACC (P/Ns 815-6100 and 815-6105) .....1

2.2 Dewpoint Sensor (P/N 814-6115) .....2

2.3 Door Frame Temperature Sensor (P/N 281-0002) .....2

**3 MOUNTING THE CONTROL LINK ACC..... 3**

**4 CALCULATING MAXIMUM AMBIENT TEMPERATURE..... 4**

**5 WIRING THE CONTROL LINK ACC..... 5**

5.1 Power and Heater Element Wiring .....5

5.2 Ratings and Current Protection .....5

**6 MOUNTING AND WIRING THE SENSORS..... 6**

6.1 The Dewpoint Sensor.....6

6.1.1 Placement..... 6

6.1.2 Note About Using RTV Sealants..... 6

6.1.3 Dewpoint Sensor Mounting Dimensions ..... 6

6.1.4 Dewpoint Sensor Wiring..... 7

6.1.5 Dewpoint Sensor Storage ..... 8

6.2 The Door Frame Temperature Sensor.....8

6.2.1 Placement..... 8

**7 NETWORK WIRING AND CONFIGURATION..... 9**

7.1 Network Connection to E2 .....9

7.2 E2 Setup of Control Link ACC Devices.....9

7.2.1 Setup Network Ports..... 9

7.2.2 Add and Connect Control Link ACCs - E2 Firmware Revision Prior to 2.8..... 10

7.2.3 Add and Connect Control Link ACCs - E2 Firmware Version 2.8 and above ..... 11

7.3 Wiring Types.....12

7.4 MODBUS Network and Daisy-Chaining.....13

7.4.1 Step 1: Disconnect Power to the Control Link ACC and Open the ACC Enclosure ..... 13

7.4.2 Step 2: Connect the MODBUS Network Cable ..... 13

7.4.3 Step 3: Set the Network Address ..... 13

7.4.4 Step 4: Set the Network Baud Rate and MODBUS Parity ..... 14

7.4.5 Step 5: Terminate the End Devices ..... 15

7.4.5.1 Termination Block Network ..... 15

7.4.6 Step 6 - Connect a Dewpoint Sensor to Control Link ACC(s) on the Network..... 15

7.4.7 Step 7: Set the Setpoint Temperature Offset ..... 15

7.4.8 Step 8 - Network Configuration Is Complete - Restore Power to the ACC..... 16

**8 THE ACC HAND-HELD TERMINAL INTERFACE..... 17**

8.1 HHT Hardware Overview .....17

8.2 Keys and Functions .....17

8.3 Hand Held Terminal Expansion Board .....18

8.4 Connecting the HHT Adapter Board.....18

8.4.1 HHT Home Screen ..... 18

8.5 HHT Interface Navigation.....19

8.5.1 Scrolling Through The Hand-Held Screens..... 19

8.5.2 Shortcut Keys (F1 and F2) ..... 19

8.5.3 ACC HHT Network Setup ..... 19

8.5.3.1 Modes of ACC Addressing ..... 19

8.5.4 The ACC HHT Interface ..... 19

8.5.4.1 ACC Start Screens ..... 19

8.5.5 ACC Status Screens ..... 20

8.5.5.1 Input Status Screen ..... 20

8.5.5.2 Output Status Screen ..... 20

8.5.6 ACC Configuration Screens ..... 20

8.5.6.1 HHT Changes When ACC is Connected to E2 ..... 20

8.5.6.2 HHT Changes When ACC is Stand-Alone ..... 20

8.5.6.3 The Main Selection Screen ..... 20

8.5.7 Upgrading ACC Using HHT ..... 21

8.5.8 Changing ACC Address Using HHT ..... 22

8.5.9 Exit HHT Mode ..... 22

**9 OPERATION ..... 23**

9.1 Control Link ACC Status LEDs ..... 23

9.1.1 Heater Status LED ..... 23

9.1.2 General Status LED ..... 23

9.1.3 TX and RX Status LEDs ..... 23

**10 ERROR MODES ..... 24**

10.1 Priority 1: FAIL: OVER TEMP ..... 24

10.2 Priority 2: FAIL: TEMP SENS ..... 24

10.3 Priority 3: FAIL: DEWPT SNS ..... 24

10.4 Priority 4: FAIL: FLASH/CLK ..... 24

10.5 Priority 5: FAIL: CONFIGURE ..... 24

**11 TROUBLESHOOTING CONTROL LINK ACCS AND THE MODBUS NETWORK ..... 25**

11.1 If Control Link ACC is Offline ..... 25

**12 SPECIFICATIONS ..... 25**

**13 PART NUMBERS AND DESCRIPTIONS ..... 26**

# 1 Overview

The Control Link ACC Anti-Condensate Controller System is a controller for anti-sweat heaters inside glass door cases and can be used either as a stand-alone device or networked with the E2 controller over the MODBUS network. There are two available models of the Control Link ACC:

- UL Listed version 7A/10A (P/N 815-6100)
- UL Recognized version 18A/26A/30A (P/N 815-6105) - requires an additional heat sink

The Control Link ACC varies the anti-sweat heaters based on the temperature of the door frame and surrounding dewpoint, providing the most efficient control possible in order to maximize energy savings.

## 2 Components

### 2.1 Control Link ACC (P/Ns 815-6100 and 815-6105)

The Control Link ACC (**Figure 2-1**) handles all aspects of anti-sweat heater control and uses solid-state switching to control the heaters. The on-board processor calculates the required heater ON time based on the dewpoint and door frame temperature readings, and controls an on-board Triac to activate and deactivate the heaters.

The controller is designed to mount in the mullion between glass doors or in any other suitable electrical enclosure, such as a raceway or on the top of the case. The door frame temperature sensor and dewpoint sensor are mounted remotely and connect to this controller with cable harnesses.

Four LEDs can be viewed on the front of the plastic enclosure. They indicate the general status, heater ON, MODBUS network transmit (TX), and MODBUS network receive (RX).

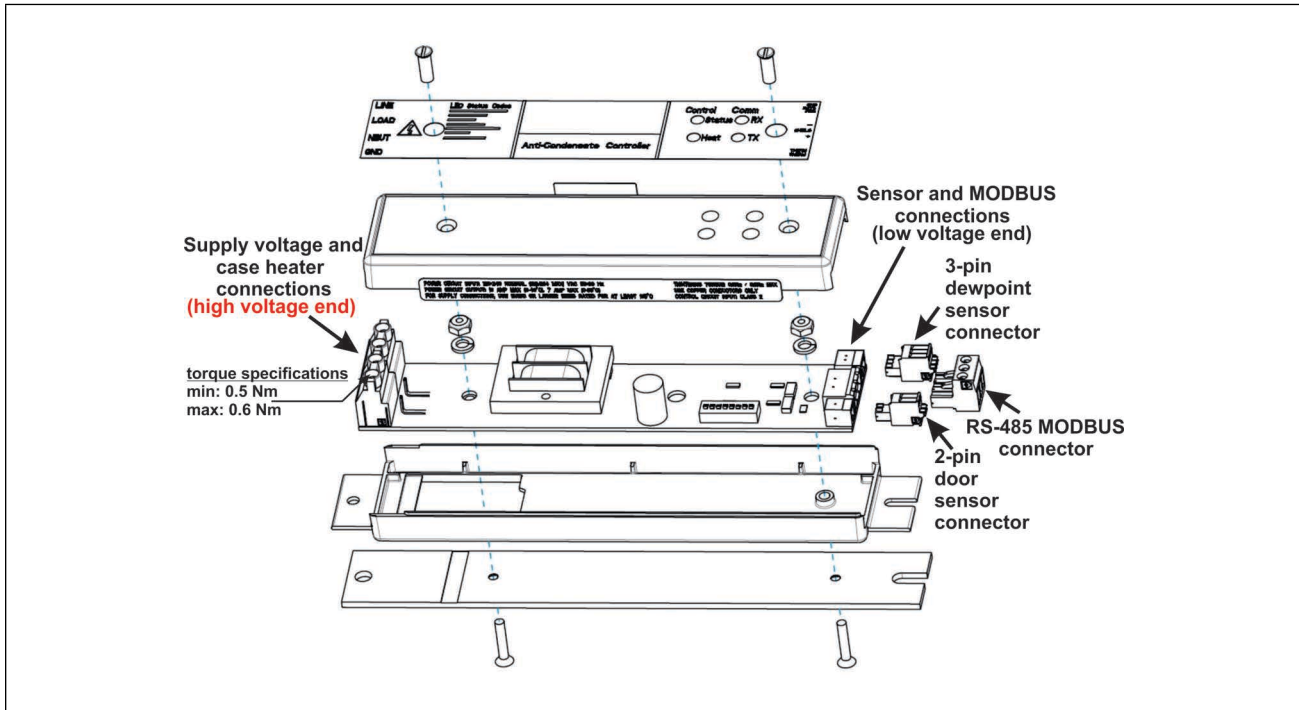
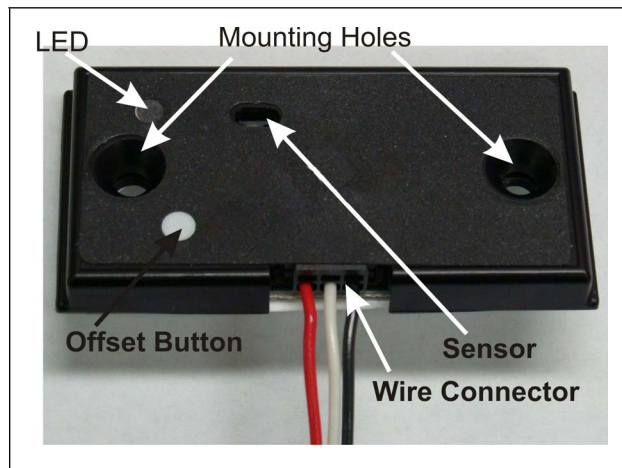

Figure 2-1 - Control Link ACC - Exploded View

## 2.2 Dewpoint Sensor (P/N 814-6115)



*Figure 2-2 - Dewpoint Sensor (814-6115)*

The Control Link ACC uses an external dewpoint sensor (**Figure 2-2**) to measure the dewpoint of the outside air next to the case doors. This sensor is typically mounted directly above or to the side of the case doors.

The dewpoint sensor is supplied in a mountable enclosure with a 3-pin connector that attaches the Control Link ACC to the dewpoint sensor (use a 3-wire 22AWG cable harness - Belden# 8771 P/N 135-8771 not supplied). The push button will increase the offset in 1-degree (Celsius) (1.8°F) increments indicated by the LED.

When Control Link ACC controllers are networked together via MODBUS, a single dewpoint sensor connected to one Control Link ACC may be shared by multiple Control Link ACC controllers.

## 2.3 Door Frame Temperature Sensor (P/N 281-0002)

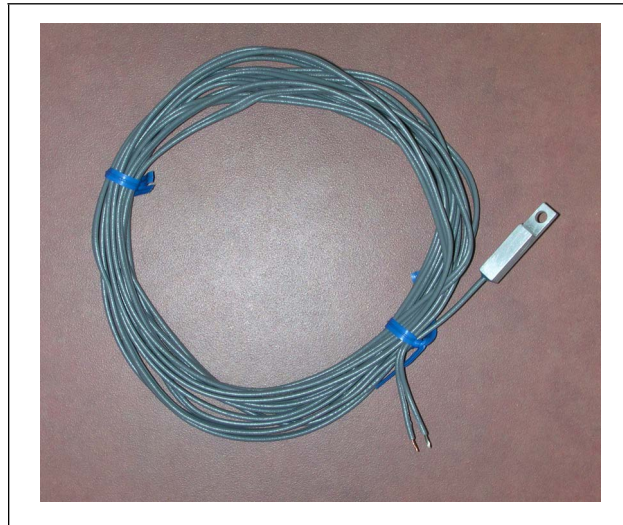

*Figure 2-3 - Door Frame Temp Sensor (281-0002)*

In addition to the indoor air dewpoint, the Control Link ACC also factors in the value of the temperature of the case door frame using a mounted temperature sensor (**Figure 2-3**). The door frame temperature sensor should be mounted to the coldest surface of the door frame. The door frame temperature sensor is supplied with a 16-foot (4.88-meter) two-wire cable, which plugs into the matching 2-pin connector on the bottom, low voltage end of the Control Link ACC (side closest to the LEDs).

### 3 Mounting the Control Link ACC

The Control Link ACC is designed to be mounted in a case mullion, but may also be mounted in the raceway or in a metal electrical enclosure on the top of the case. **Figure 3-1** shows examples of where the Control Link ACC may be mounted.

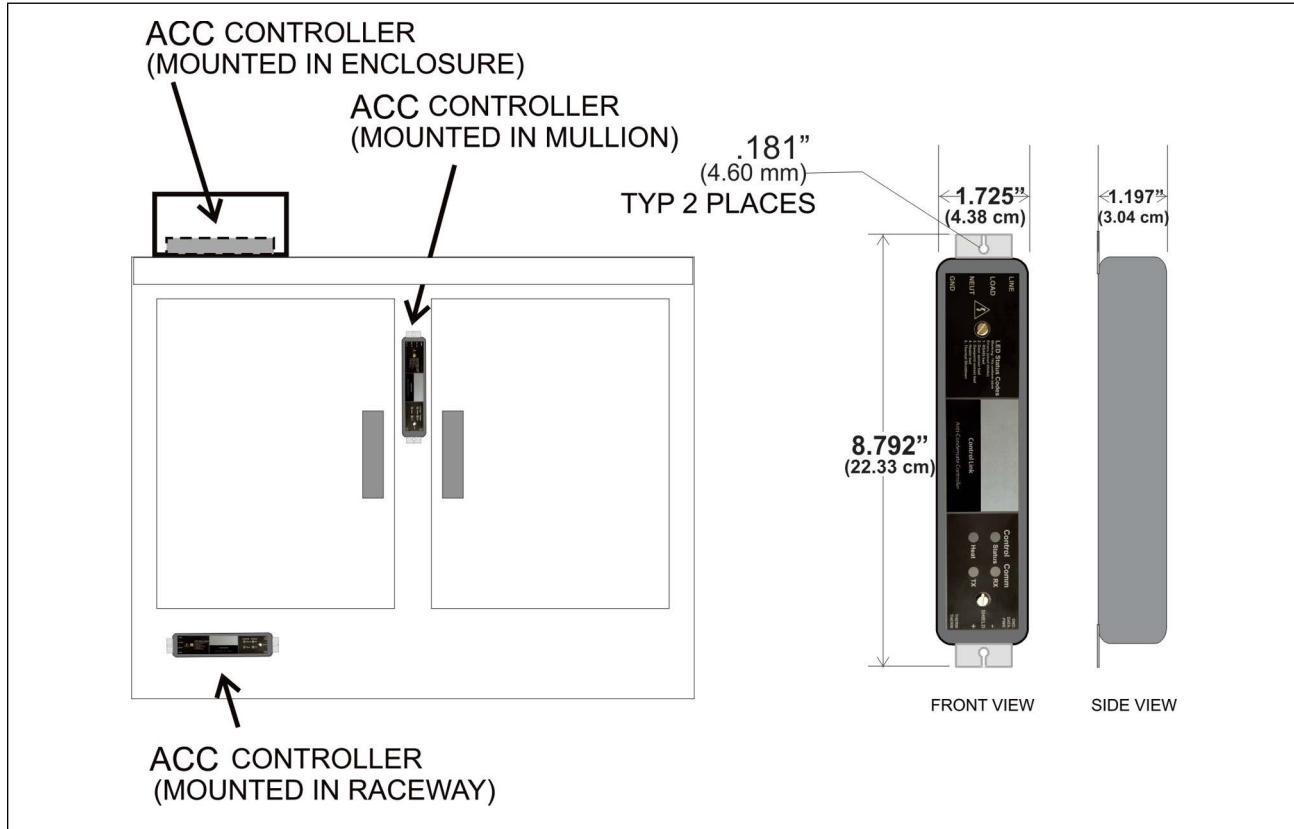

Figure 3-1 - Control Link ACC Mounting

Use the two mounting tabs at the top and bottom of the enclosure to screw the enclosure to the case wall, raceway, or enclosure.

Use 9/64" (3.57 mm) drill pilot holes for mounting, and secure the Control Link ACC to the metal surface using #8-32 thread forming screws. Mounting screws are not included with the Control Link ACC.

For heater current greater than 10A, the Control Link ACC UL Recognized version with external heat sink must be used (P/N 815-6105). The heat sink of the Control Link ACC must be **securely mounted against a large heat-conductive surface**. Using thermal grease, the Control Link ACC has a metal back which acts as a heat sink, dissipating heat from the Triac that controls the heater.

**The metal must be mounted against a conductive metal surface** so heat can be conducted out of the controller. Failure to secure against the case mullion or other metal surface may cause controller overheating and shutdown.

## 4 Calculating Maximum Ambient Temperature

Figure 4-1 shows the effects of adding an external heat sink with a 0.51°C/Watt (0.92°F/Watt) rating (using thermal grease to ensure optimum thermal conductivity). Note that the 0.51°C/Watt (0.92°F/Watt) heat sink rating is characteristic of typical case mullions.

An external heat sink is required for heater currents (greater than) > 10Amps.

To calculate the maximum ambient temperature at which the ACC should run with an additional external heat sink, choose a current-amperage rating that will be operating for the case (y-axis) and plot the maximum allowed operating temperature (x-axis) on the graph. For example, with an external heat sink at 26Amps, the maximum ambient temperature would be 40°C (149°F).

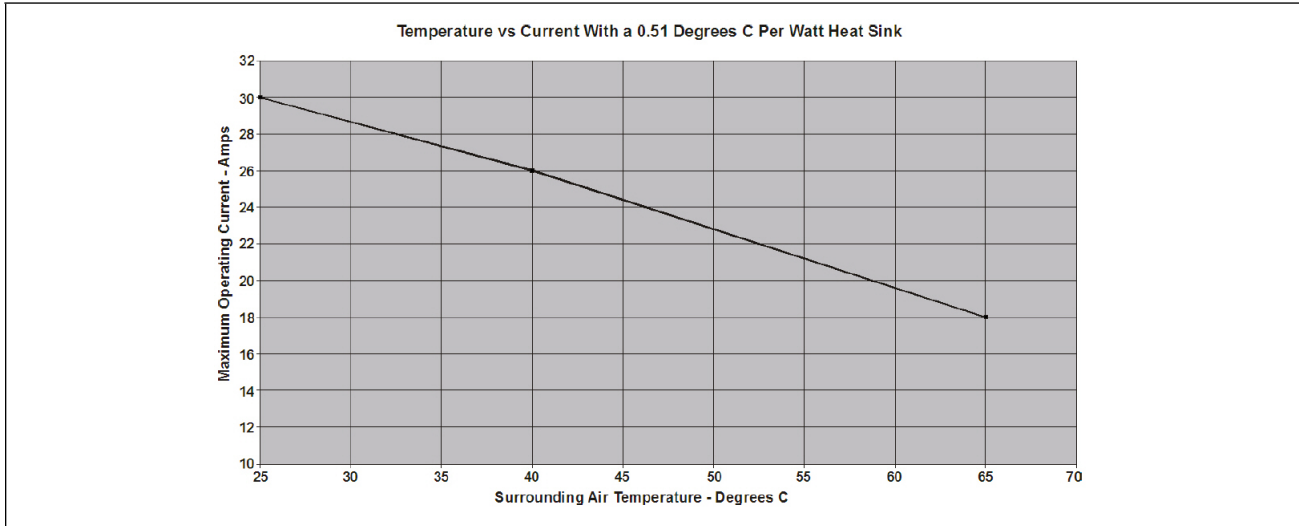

Figure 4-1 - Ambient Temperature Calculation - additional heat sink

For heater current greater than 10A, the heat sink of the Control Link ACC must be **securely mounted against a large heat-conductive surface**. Using thermal grease, the Control Link ACC has a metal back which acts as a heat sink, dissipating heat from the Triac that controls the heater. **The metal must be mounted against a conductive metal surface** so heat can be conducted out of the controller. Failure to secure against the case mullion or other metal surface may cause controller overheating and shutdown.

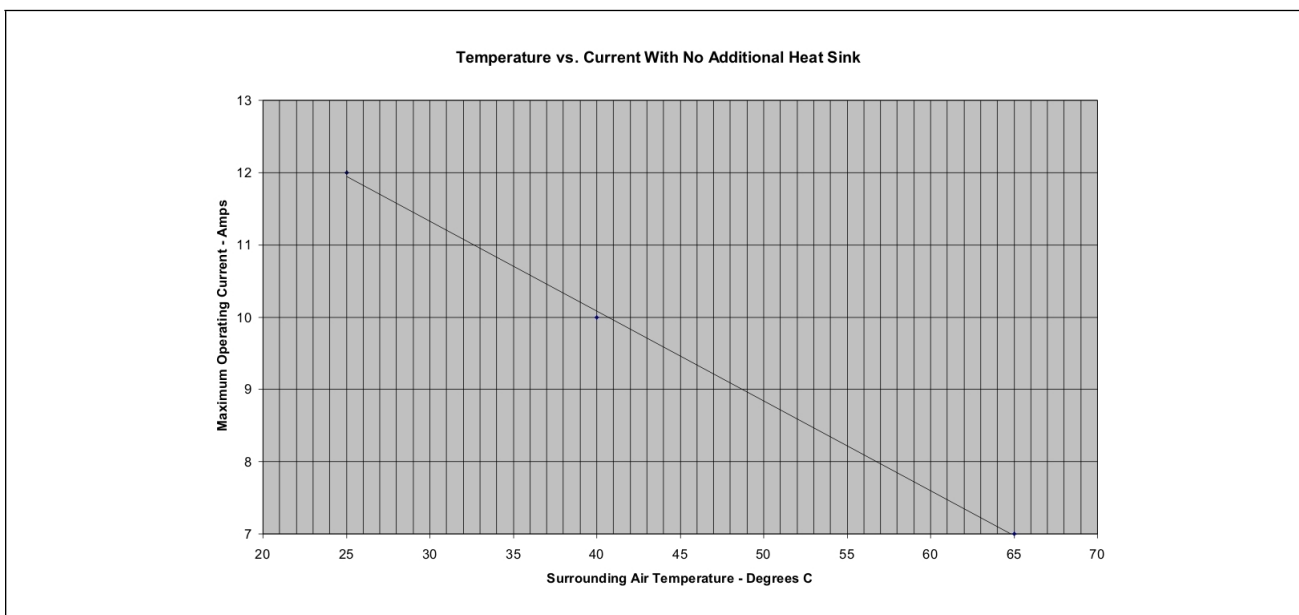

Figure 4-2 - Ambient Temperature Calculation - no external heat sink



## 5 Wiring the Control Link ACC

### 5.1 Power and Heater Element Wiring

The screw connectors on the main voltage end of the Control Link ACC enclosure are where the connections to supply voltage and the case door heater element(s) are made.

#### ⚠ WARNING

Connect The Line Voltage Only To The High Voltage End Of The Acc, Which Contains A Non-removable 4-terminal Block. Otherwise, Damage To The Board May Result

#### ⚠ WARNING

Over-current Protection Of The Load Must Be Done Outside Of The Control Link Acc. The Acc Does Not Have Internal Fusing.

Connect the **NEUT** terminal to the NEUTRAL side, and the **LINE** terminal to the HOT side of 120/240 Nominal (102VAC to 264VAC), 50/60Hz line voltage.

The **LOAD** terminal carries supply voltage when the door heater Triac relay is ON (closed). Connect the **LOAD** terminal and NEUTRAL side of the line voltage to the case door heater elements. All heater elements in the door frame and all doors of that frame should be connected **in parallel** to the Control Link ACC.

Connect the **GND** terminal on the controller to Ground.

#### NOTE

For supply connectors, use 16AWG or larger wires rated for at least 105 °C.

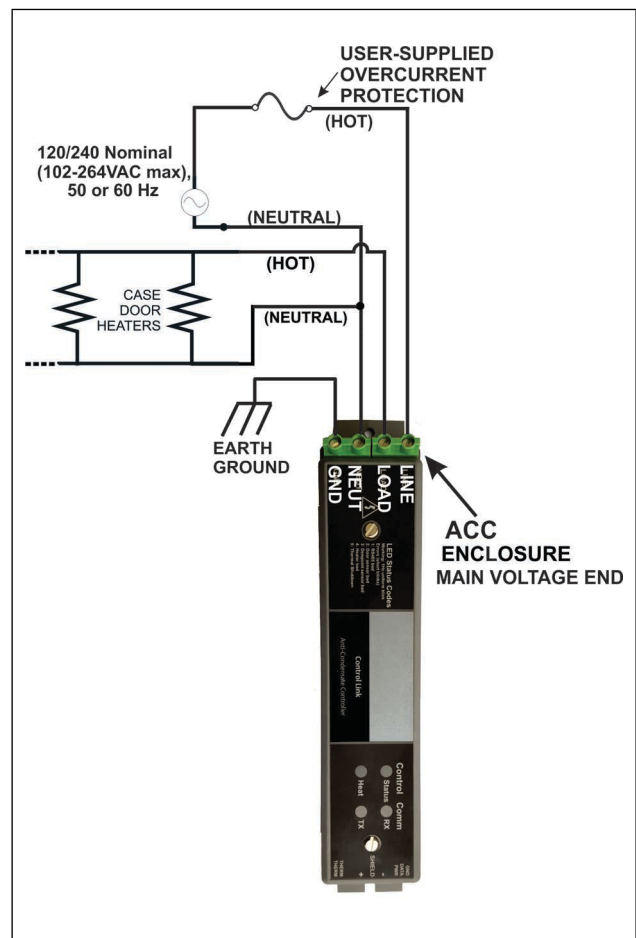

Figure 5-1 - Power/Heater Wiring

### 5.2 Ratings and Current Protection

The Control Link ACC (P/N 815-6100) is UL Listed for up to 10A max (40°C) and 7A max (65°C). The Control Link ACC (P/N 815-6105) is UL Recognized, with external heat sink, for up to 30A max (25°C), up to 26A max (40°C), and up to 18A max (65°C).

## 6 Mounting and Wiring the Sensors

### 6.1 The Dewpoint Sensor

#### 6.1.1 Placement

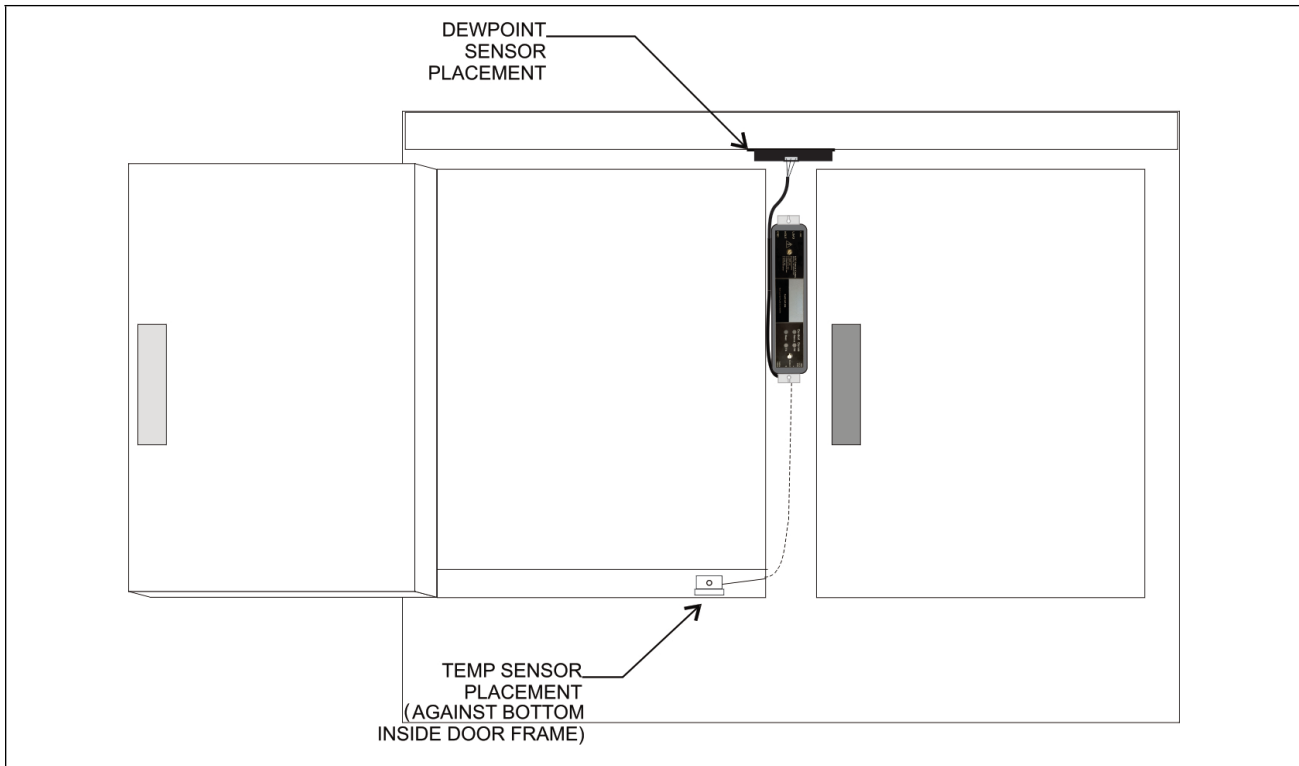

Figure 6-1 - Sensor Placement

In order for the Control Link ACC to function properly, the dewpoint sensor **must** be placed where it can measure the dewpoint of the air **outside** the case. Mount the sensor underneath the top side of the case in the area just above the top of the doors (Figure 6-1).

A 0.25" x 0.25" (6.35 mm x 6.35 mm) notch in the edge of the metal frame behind the sensor may be required for the wires connecting the dewpoint sensor to the Control Link ACC. DO NOT let any RTV sealants touch the sensor element and keep the sensor element as far as possible from RTV-sealed areas.

Do NOT mount the dewpoint sensor near the bottom of the case or any place where cold air from the case can affect the sensor reading. Avoid mounting the sensor in an area with excessive water spray or moisture, extremely dirty environments, near heat sources, or in the direct path of HVAC returns. Secure the sensor to the mounting location with the two included screws (P/N 031-6005) as shown in Figure 6-2. Copeland recommends using pilot holes for the screws. Tighten the screws just enough to secure the sensor without warping the sensor housing.

#### 6.1.2 Note About Using RTV Sealants

Placing the dewpoint sensor in either of these locations may require a hole to be drilled in the case to run the wire from the sensor to the Control Link ACC. Use caution when sealing this hole with RTV sealants — the sensor element is sensitive to high concentrations of RTV. Do not let any RTV sealants touch the sensor element, and keep the sensor element as far as possible from where the hole is sealed.

#### 6.1.3 Dewpoint Sensor Mounting Dimensions

The dewpoint sensor's mounting holes have 2.35" (5.97 cm) spacing. Choose a location as close to the case doors as possible, preferably directly over the doors or (if necessary) on top of the case. Secure the sensor to the mounting location with the two screws provided. Note that the enclosure allows clearance for a nut driver on the screw head. Figure 6-2 shows the mounting dimensions.

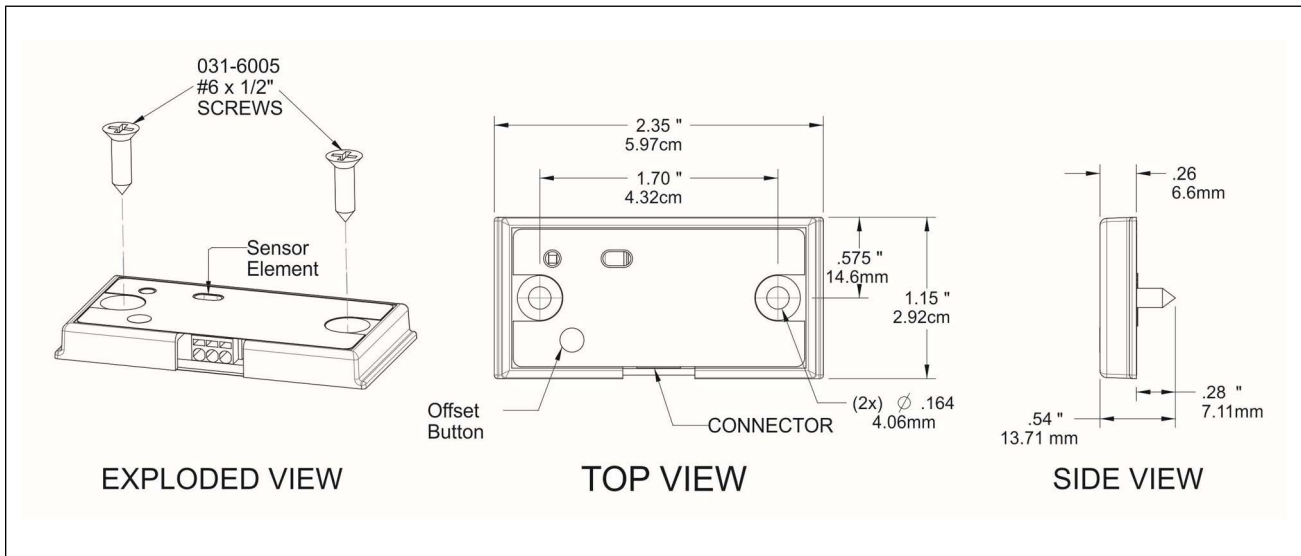

Figure 6-2 - Dewpoint Sensor Dimensions

It may be necessary to cut a 0.25" x 0.25" (6.35 mm x 6.35 mm) notch in the edge of the metal frame behind the sensor for the wires to pass through.

### 6.1.4 Dewpoint Sensor Wiring

The dewpoint sensor cable can be 20-24 AWG range. Copeland recommends Belden# 8771 (P/N 135-8771) 22AWG cable or equivalent (not supplied). To install or remove wires from the dewpoint sensor connector, insert a small screwdriver, such as a Phoenix Contact (P/N 011-6993) PTSM Screwdriver (not supplied), into the top rectangular slots on the connector (above the wire terminals) until it stops; insert or remove wires as shown in **Figure 6-4**. Insert the three wires on the other end of the cable to the matching 3-pin connector of the low voltage end of Control Link ACC by pressing in the orange tabs above the terminals using the small screwdriver. Ensure the wire colors match for the Power, Data and Ground terminals on Dewpoint Sensor and the Control Link ACC.

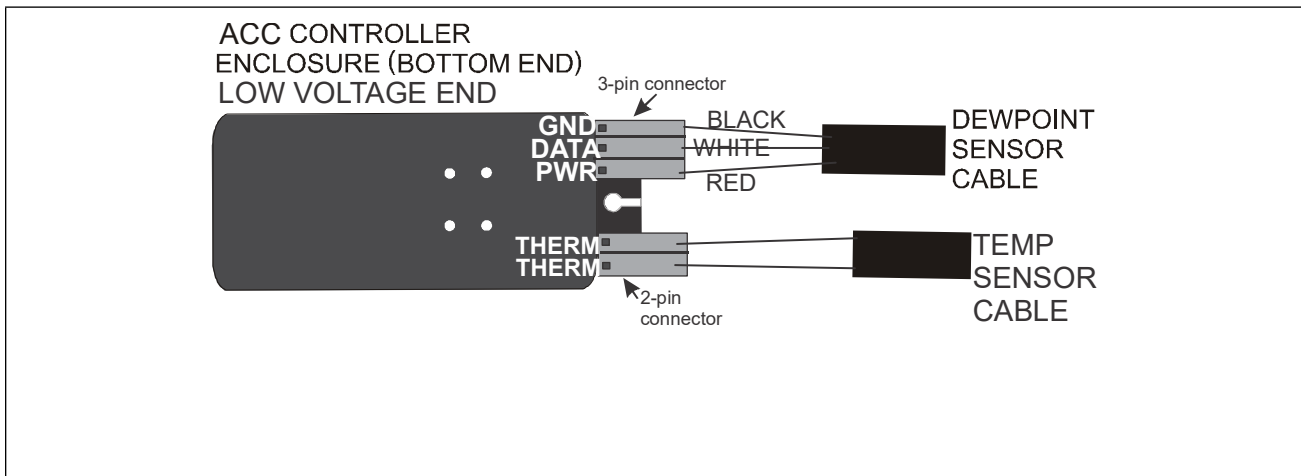

Figure 6-3 - Dewpoint Sensor Wiring

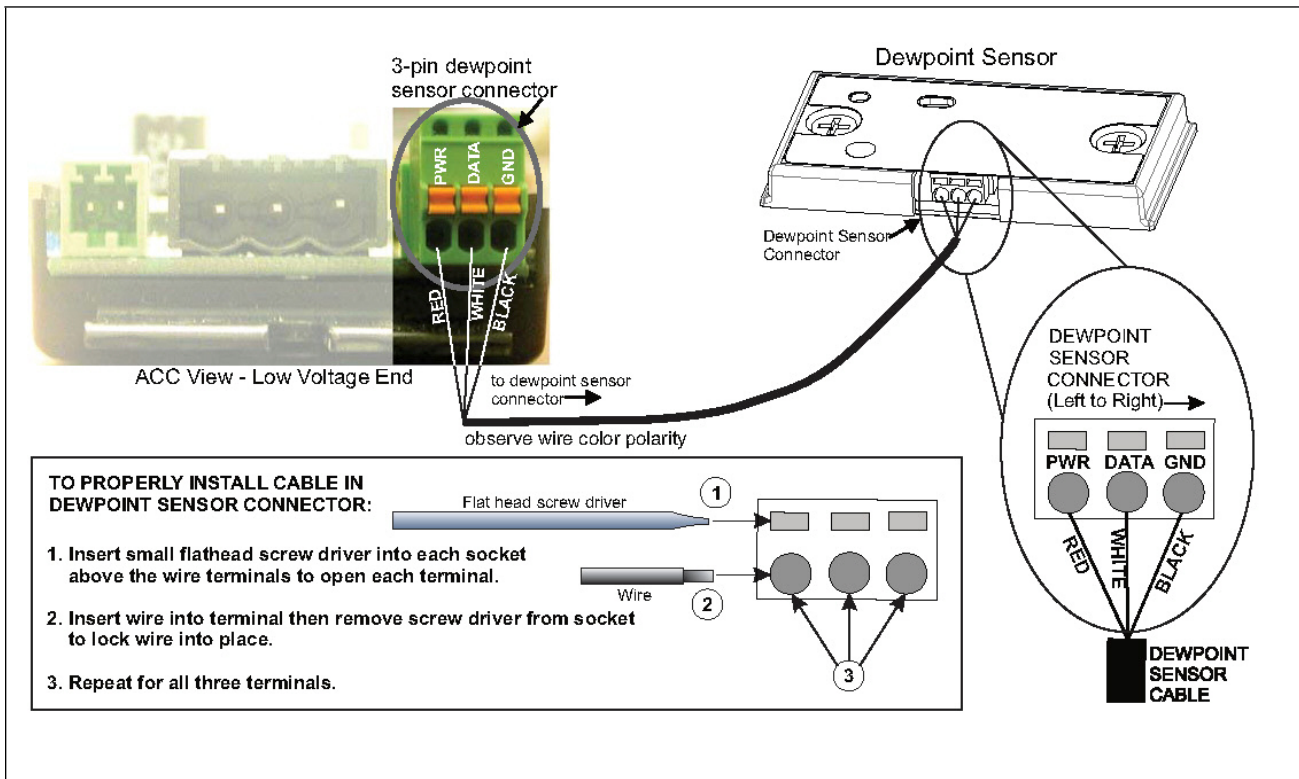

Figure 6-4 - Dewpoint Sensor Connector - ACC View

## 6.1.5 Dewpoint Sensor Storage

Prior to installation, dewpoint sensors should be stored separately from the cables. Do not store cables and sensors together for a long period of time in a closed box or bag. The sensor should be separated from the cables when a shipment is received and stored apart, preferably exposed to room air. The sensors can become contaminated by outgassing from the cable insulation if kept in a closed up box or bag with the cable. Contamination can be reversed with exposure to room air over a period of weeks or in a temperature/humidity chamber over a period of three days.

**NOTE** If replacing the dewpoint sensor, replace the entire assembly (keep the existing cable).

## 6.2 The Door Frame Temperature Sensor

### 6.2.1 Placement

The door frame temperature sensor should be placed in an area where it can measure the temperature of the door frame in the location on the door frame that stays the coldest. The coldest spot on a door frame is usually the bottom horizontal section of the stationary frame, under the center door (for cases with even-numbered doors), or near the center mullion (for cases with odd-numbered doors). Cooler doors may also be coldest at the top center of the frame. **Figure 6-1** on page 6 shows an example of placement in a case with even-numbered doors — the sensor is placed under the door just to the left of the center mullion where the Control Link ACC is installed. **Do not mount the sensor outside the case mullion - mount the sensor inside the case mullion.**

Mount the case door frame temperature sensor along the door frame inside the frame. Secure the sensor in place by screwing it to the door frame using the mounting hole.

The sensor is supplied with a 16-foot (4.88-meter) cable. Connect the sensor into the 2-pin connector (labeled **THERM**) at the bottom (closest to the LEDs), low-voltage end of the Control Link ACC.

## 7 Network Wiring and Configuration

If each Control Link ACC will be configured with its own dewpoint sensor, it is not necessary to network the Control Link ACC together. However, when networked, multiple Control Link ACC controllers may use a single dewpoint sensor. Furthermore, because the Control Link ACC is a MODBUS-compliant device, a site controller can be programmed to communicate with the Control Link ACC controllers via MODBUS, supporting remote configuration and data acquisition.

The E2 controller supports networking of up to 63 Control Link ACC controllers.

### 7.1 Network Connection to E2

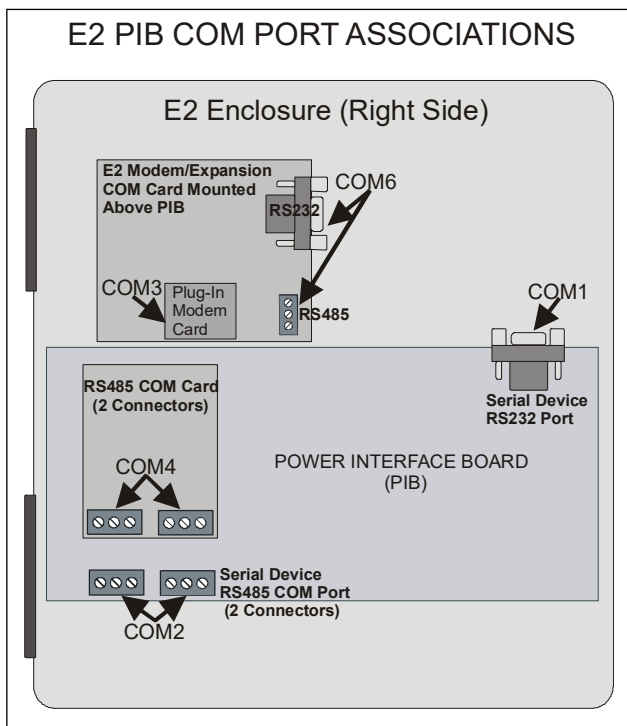

Figure 7-1 - Location of E2 COM Ports

Connecting a Control Link ACC to an E2 unit requires the E2 to be version 2.71 or above. Contact Copeland for upgrade information if the controller is a version before 2.71.

An E2 has up to three COM ports that can be assigned for MODBUS communication (COM2, an RS485 port on the E2 power interface board, and COM4 and COM6, which are optional ports requiring expansion cards). COM ports can only be used for one function; in other words, if COM2 is set up as the I/O network, you cannot connect MODBUS devices to COM2. Ensure your E2 is equipped with an RS485 COM Card (P/N 637-4890) and configured in E2 General Services (Menu **8** **7** **3** **1**, **Serial** tab) to enable COM4 or an E2 Expansion COM Card (P/N 637-4871) to enable COM6.

Connect the MODBUS network cable to the three-terminal connector on the COM port you wish to assign as MODBUS. Like other Control Link connections, wire RS485+ to RS485+, RS485- to RS485-, and the shield cable to the middle terminal. If the E2 will be the first device in the daisy-chain, set the port's termination jumpers to the TERMINATED & BIASED position (all three jumpers UP); otherwise, set all jumpers DOWN if not the first device.

### 7.2 E2 Setup of Control Link ACC Devices

#### 7.2.1 Setup Network Ports

Before setting up a Control Link ACC, the port on the E2 that has the MODBUS cable connected must be set up as a MODBUS port.

1. Log in to the E2 with Level 4 access.
2. Press **Menu** followed by **7** **3** **1** - **General Controller Info**.
3. Press **Ctrl** + **3** to open the **Serial** tab of the General Controller Info setup screens:

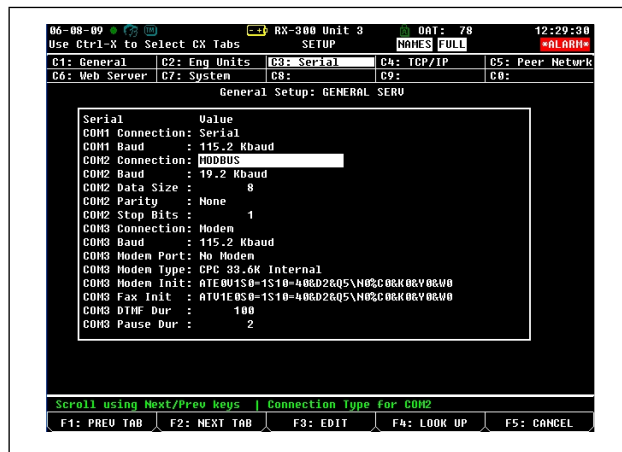

Figure 7-2 - Serial Communications Manager Screen

4. This screen will have a **“Connection”** field for all COM ports on the E2. Highlight the COM port connection field that will be used for Control Link, and press **F4** - **LOOK UP**. From the list of network types, select **MODBUS**.
5. Four fields will become visible underneath the COM port connection field, which pertain to the way the device communicates:
  - **Baud** - Default setting is **19.2k**. The baud rate setting should be set to match the baud rate dip switch settings of all Control Link devices. (All devices connected to the same COM port should be set to the same baud rate.)
  - **Data Size** - Leave this field at the default value (**8**).
  - **Parity** - Leave this field at the default value (**None**).
  - **Stop Bits** - Leave this field at the default value (**1**).
6. Press **Menu** to save changes and exit.

## 7.2.2 Add and Connect Control Link ACCs - E2 Firmware Revision Prior to 2.8

To enable communications between E2 and the Control Link units, the devices must be added and addressed in E2.

1. Log in to the E2 with Level 4 access.
2. Press **Menu** & **7** & **7** & **2** - **Connected I/O Boards and Controllers**.

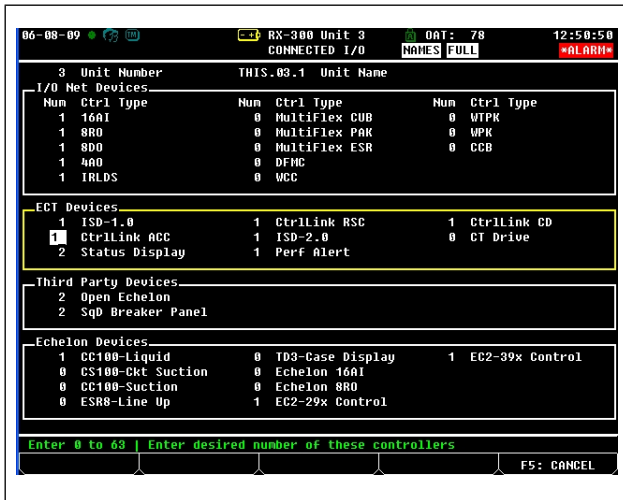

Figure 7-3- Connected I/O Screen

3. In the Connected I/O screen, in a section labeled **ECT Devices**. Enter the number of ACC devices in the **CtrlLink ACC** number field.
4. Press **Esc** to return to the Network Setup menu, then select **3** - **Controller Setup**.
5. Locate the CtrlLink ACC units you added to the network list (press **Page Up** and **Page Down** to scroll through the list). The default name for a Control Link ACC begins with a two-letter designator of the model type (**AC** for anti-condensate). If desired, enter a new name for each device in the **Name** field.

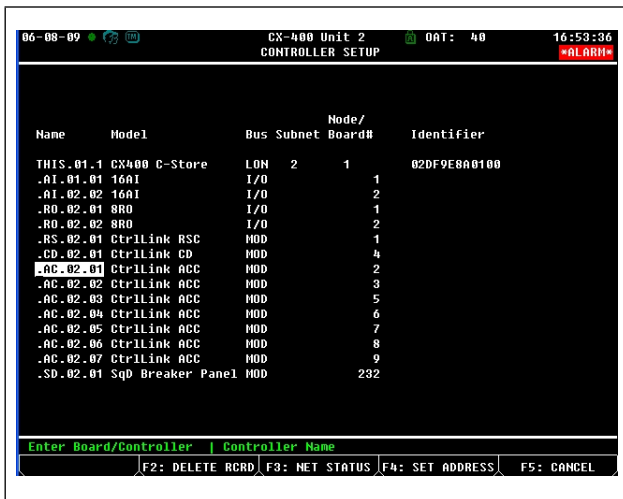

Figure 7-4- Controller Setup Screen

6. By default, each CtrlLink ACC in the network list has a board number of 0. To set the address and begin communication, press **F4** and select **1** - **Select Address**. In the list of MODBUS devices, choose the address number corresponding to the Control Link ACC's dip switch/jumper setting, and press **Enter** to select it. If a network ID has already been selected, its name will be shown next to the network ID in this list. If the network ID you are trying to assign has already been used, you must set the network ID dip switch/jumper on this device to a different number that is not being used.

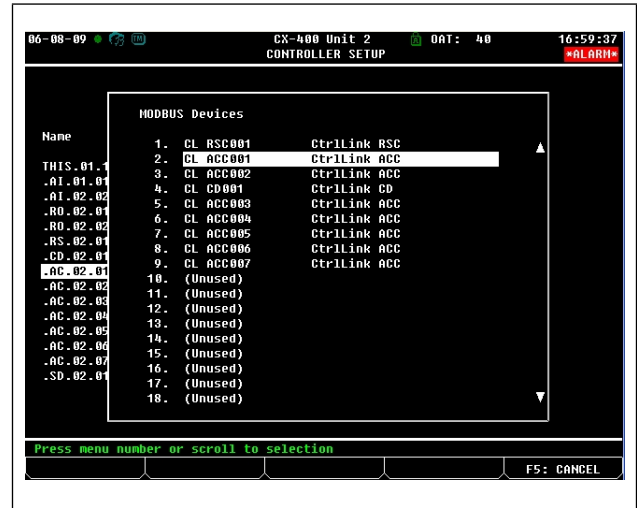

Figure 7-5- List of MODBUS Devices

7. Repeat **Steps 5** and **6** until each Control Link ACC device has a name and address.
8. When finished, press **Esc** to return to the Network Setup menu, then press **1** - **Online Status (Figure 7-6)**. Locate the Control Link ACCs you set up, and look at each device's status in the **Status** field. You will see one of the following messages:
  - **Online** - The Control Link ACC is communicating normally.
  - **Offline** - The Control Link ACC is not communicating, has not been commissioned, is not functional, or is not powered up. Verify the Control Link ACC is powered up, wired correctly, and has the proper network address, baud rate, and parity (see **Section 11, Troubleshooting Control Link ACCs and the MODBUS Network**).
  - **Unknown** - The Control Link ACC is not communicating or has not been commissioned. Verify the Control Link ACC is powered up, wired correctly, and has the proper network address, baud rate, and parity (see **Section 11, Troubleshooting Control Link ACCs and the MODBUS Network**).
  - **No Port** - No port is set up in the E2 Serial Configuration Manager to be a MODBUS port. Follow the instructions in **Section 7.2.1, Setup Network Ports**).

- **Wrong FW Rev** - This message is likely caused by the Control Link ACC having a firmware version older than the minimum revision required by E2 for communication. Replace the Control Link ACC with a new controller that has the latest version of firmware on it.

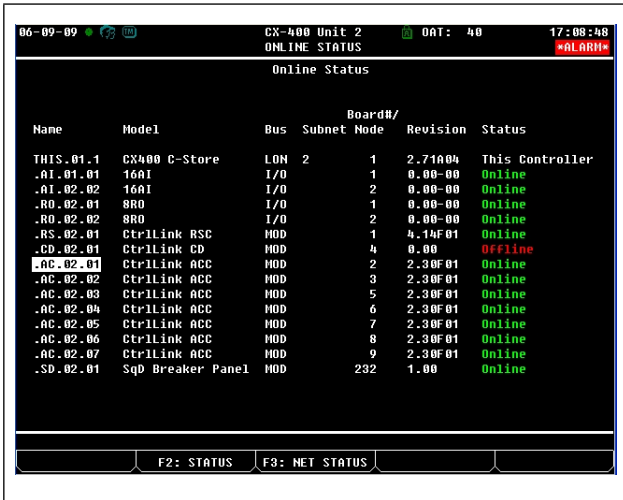

Figure 7-6 - Online Status Screen

### 7.2.3 Add and Connect Control Link ACCs - E2 Firmware Version 2.8 and above

To enable communications between E2 and the Control Link units, the devices must be added and addressed in E2.

1. Log in to the E2 with Level 4 access.
2. Press **Menu** & **7** & **7** & **2** - **Connected I/O Boards and Controllers**.

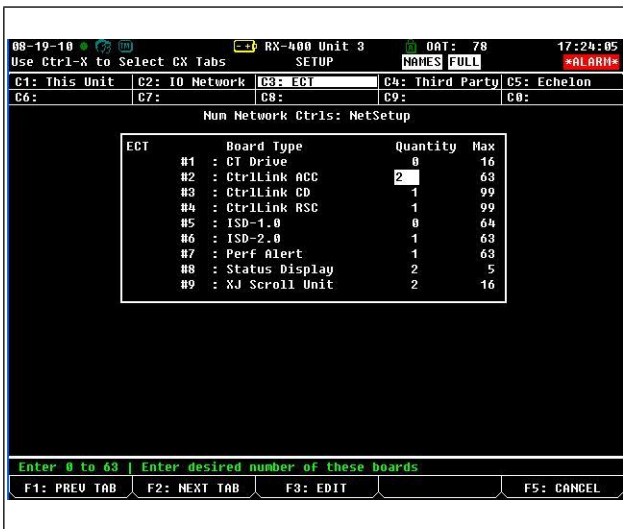

Figure 7-7 - Connected I/O Screen

3. In the Connected I/O screen, under the **ECT** tab, Enter the number of ACC devices in the **CtrlLink ACC** number field.
4. Press **Left Arrow** to return to the Network Setup menu, then select **1** - **Network Summary**.

5. Locate the CtrlLink ACC units you added to the network list (press **Page Up** and **Page Down** to scroll through the list). The default name for a Control Link ACC begins with a two-letter designator of the model type (**CL** for ControlLink) and a three-letter designator for **ACC** (anti-condensate controller).



Figure 7-8 - Network Summary Screen

6. By default, each CtrlLink ACC's board number in the network list is indicated by a - (dash). To set the address and begin communication, press **F4** to Commission. (If you have more than one MODBUS network, specify which network you want the device to belong to.) A screen will open that will allow you set the address:

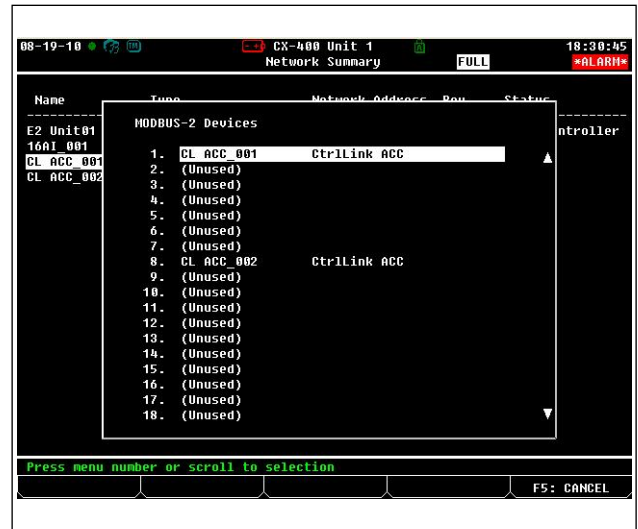

Figure 7-9 - Set the Address of the ACC

- In the list of MODBUS devices, choose the address number corresponding to the Control Link ACC's dip switch/jumper setting, and press **Enter** to select it. If a network ID has already been selected, its name will be shown next to the network ID in this list. If the network ID you are trying to assign has already been used, you must set the network ID dip switch/jumper on this device to a different number that is not being used.

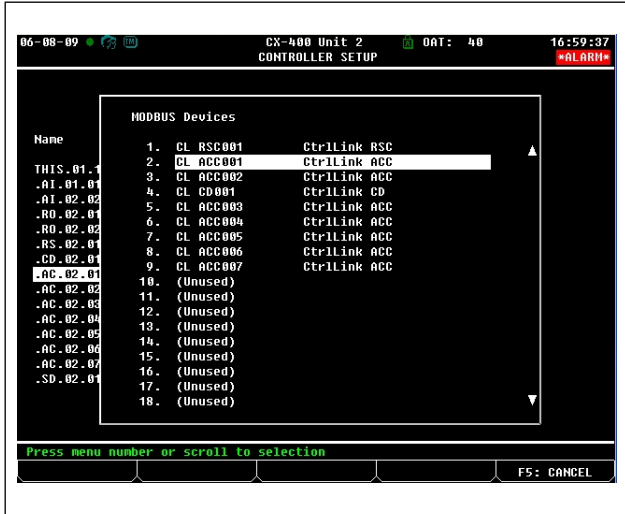

Figure 7-10 - List of MODBUS Devices

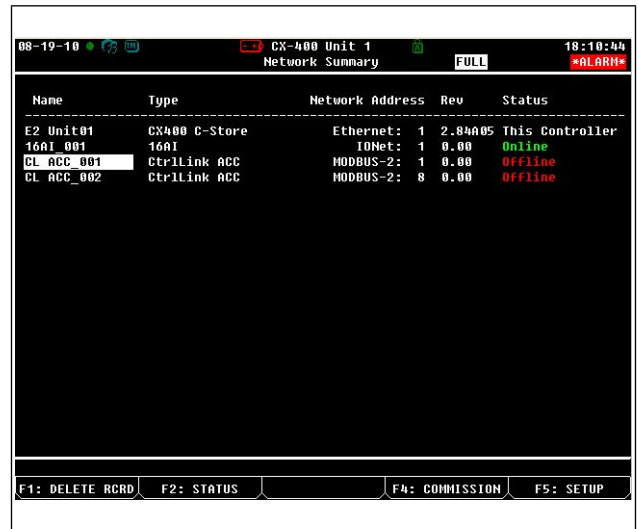

Figure 7-11 - Network Summary Screen

- Repeat **Steps 5** and **6** until each Control Link ACC device has been commissioned.
- When finished, press **ESC** to return to the Network Setup menu, then press **1** - **Network Summary** (Figure 7-8). Locate the Control Link ACCs you set up, and look at each device's status in the **Status** field. You will see one of the following messages:

- Online** - The Control Link ACC is communicating normally.
- Offline** - The Control Link ACC is not communicating, has not been commissioned, is not functional, or is not powered up. Verify the Control Link ACC is powered up, wired correctly, and has the proper network address, baud rate, and parity (see **Section 11, Troubleshooting Control Link ACCs and the MODBUS Network**).
- Unknown** - The Control Link ACC is not communicating or has not been commissioned. Verify the Control Link ACC is powered up, wired correctly, and has the proper network address, baud rate, and parity (see **Section 11, Troubleshooting Control Link ACCs and the MODBUS Network**).
- No Port** - No port is set up in the E2 Serial Configuration Manager to be a MODBUS port. Follow the instructions in **Section 7.2.1, Setup Network Ports**.
- Wrong FW Rev** - This message is likely caused by the Control Link ACC having a firmware version older than the minimum revision required by E2 for communication. Replace the Control Link ACC with a new controller that has the latest version of firmware on it.

### 7.3 Wiring Types

Copeland specifies Belden #8761 shielded twisted pair cables for use as MODBUS wiring (or Belden #82761 and Belden #88761 for plenum installations).

If the recommended cable is not available in your area, be sure the wiring meets or exceeds the following specs:

Shielded?	Yes
Conductor Type	Twisted Pair
Gauge	18 - 24 AWG
Capacitance between signal wires	31 pF/ft or less (9.45 m) or less
Capacitance between signal and shield	59 pF/ft or less (17.98 m) or less
Maximum Length	4000 ft/18 to 22 AWG (1219.2 m) 2500 ft/24 AWG (762 m)
Nominal Impedance	120Ω±50Ω



## 7.4 MODBUS Network and Daisy-Chaining

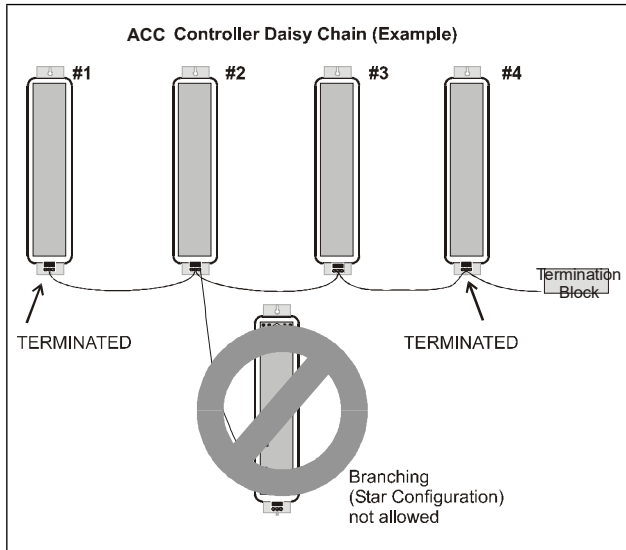

Figure 7-12 - Control Link ACC Daisy Chain

Control Link ACC must be networked in a single open communications loop, or **daisy chain**. A daisy chain connects all the Control Link ACCs together in a single unbranched series, and requires termination jumpers to be set on the controllers at either end of the chain. No branching or “star configurations” are allowed.

### 7.4.1 Step 1: Disconnect Power to the Control Link ACC and Open the ACC Enclosure



**WARNING**

Disconnect The Supply Power From The Control Link Acc Before Opening The Enclosure. Opening The Enclosure While The Control Link Acc Is Powered May Result In Electrocutation.

Connecting a Control Link ACC to a MODBUS network requires you to remove the top cover from the Control Link ACC enclosure. Press down the tab at the main voltage end of the enclosure, and remove front cover of the Control Link ACC. If the Control Link ACC is already mounted in the case mullion, you may have difficulty removing the front cover; if so, loosen the top mounting screw before pressing the tab.

### 7.4.2 Step 2: Connect the MODBUS Network Cable

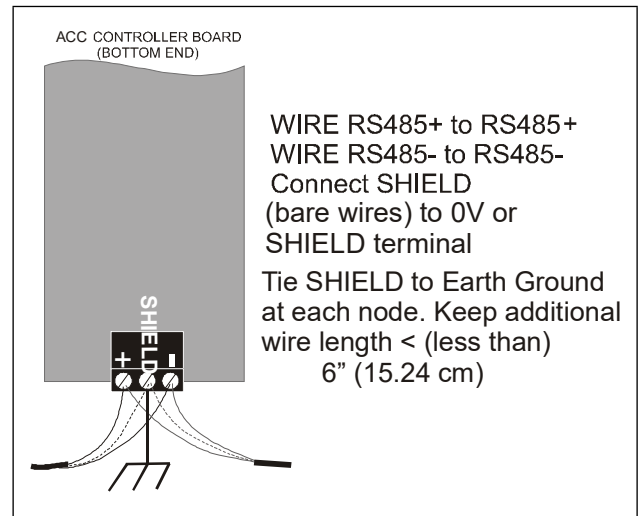

Figure 7-13 - Control Link ACC Network Connection

MODBUS network cable has two conductors plus a shield. For each Control Link ACC, connect the two conductors to the 485 terminals of the MODBUS connector labeled + and - (at the bottom, low voltage end of the enclosure), making sure to use the same wire colors for each Control Link ACC connection. For example, if the conductor wire colors are BLACK and WHITE, use BLACK for all 485+ terminals and WHITE for all 485- terminals (or vice-versa). Connect the bare (SHIELD) wire to the center Shield terminal (0V terminal on the E2).

### 7.4.3 Step 3: Set the Network Address

#### NOTE

If you are networking Control Link ACC only for purposes of sharing a dewpoint sensor, you do not need to set a network address. Set all network address dip switches or jumpers to the DOWN (OFF) position. This will allow the Control Link ACC to share a dewpoint sensor as long as the network is physically present and terminated correctly. The network address is only necessary for assigning a network ID for MODBUS applications.

Depending on the hardware revision, the Control Link ACC board has either eight dip switches or eight three-pin jumpers, located in between the controller and network status LEDs. Switches or jumpers 1-6 set the network ID for the controller. Switches 7 and 8 set the network baud rate and parity.

Each Control Link ACC that will use the MODBUS network must have a unique network ID. Number each controller in sequence, starting with 1. Refer to **Figure 7-14** for dip switch and jumper settings

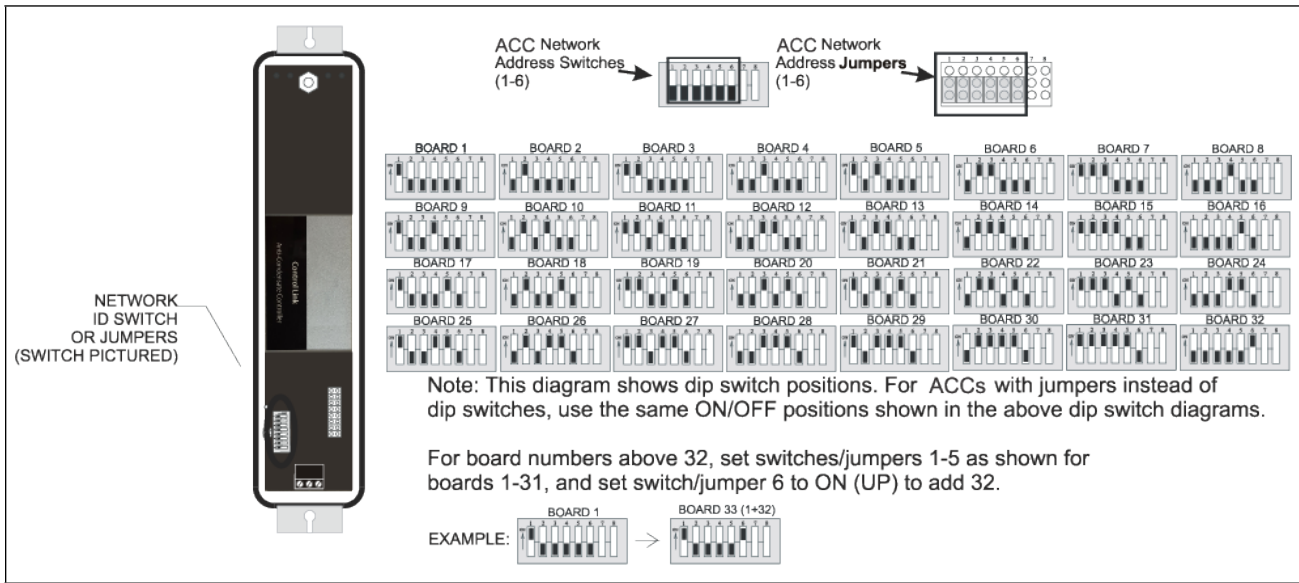

Figure 7-14 - Control Link ACC Network ID Dip Switch/Jumper Settings

#### 7.4.4 Step 4: Set the Network Baud Rate and MODBUS Parity

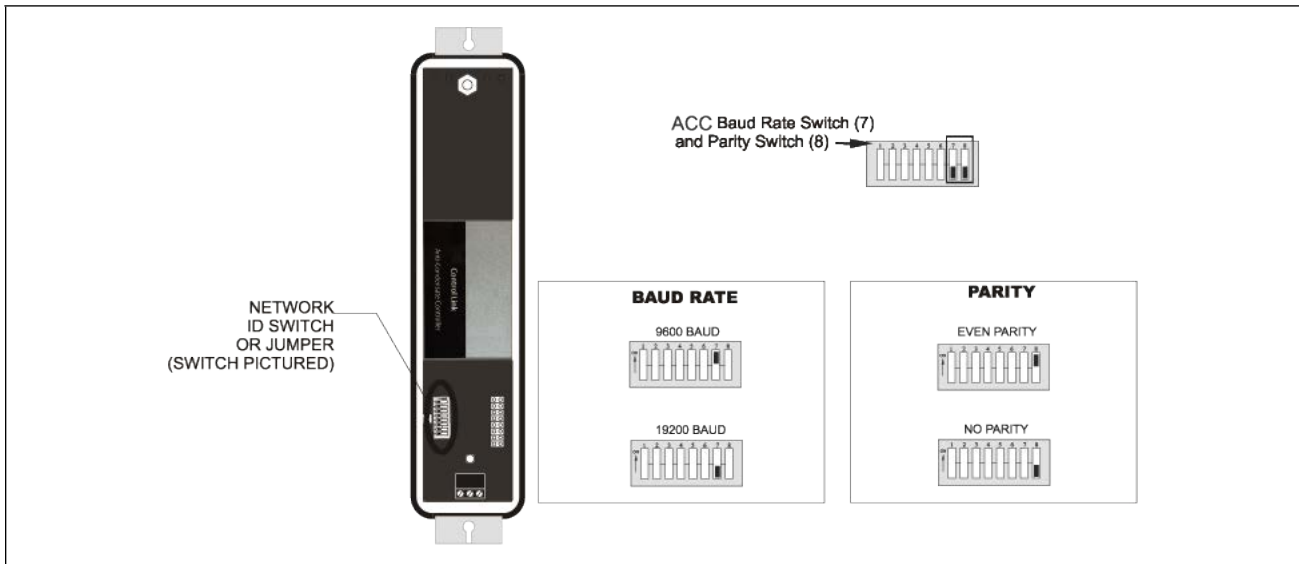

Figure 7-15 - Control Link ACC Network Baud Rate/Parity Dip Switch/Jumper

**NOTE** If you are networking Control Link ACC only for purposes of sharing a dewpoint sensor, you do not need to set a baud rate or parity. Set all dip switches or jumpers to the DOWN (OFF) position. This will allow the Control Link ACC to share a dewpoint sensor as long as the network is physically present and terminated correctly. The dip switches or jumpers are only necessary for assigning a network ID for MODBUS applications.

In order for the Control Link ACC to communicate with each other on the MODBUS network, they must all be set to communicate at the same baud rate and parity.

Switch/jumper 7 determines the baud rate at which the controllers communicate. When switch/jumper 7 is ON, the Control Link ACC will operate at 9600 baud. If switch/jumper 7 is OFF (default), the Control Link ACC will operate at 19200 baud. Switch/jumper 8 determines the MODBUS network parity. Some MODBUS-enabled site controllers require even network parity; to enable even parity, set switch/jumper 8 to the ON position. For site controllers that require no parity, set switch/jumper 8 to the OFF (default) position.

### 7.4.5 Step 5: Terminate the End Devices

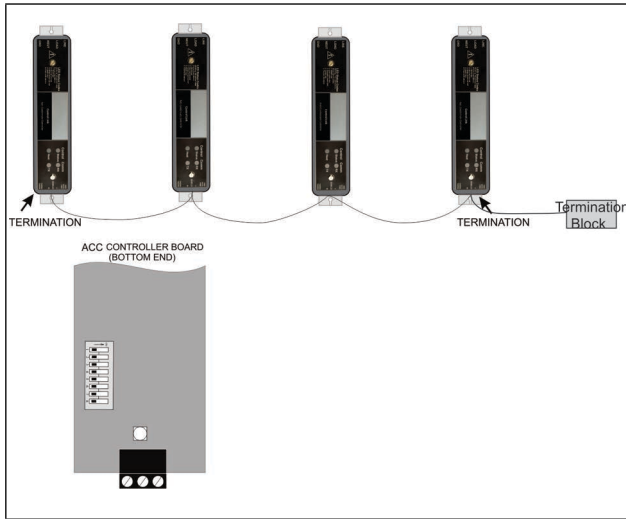

Figure 7-16 - Control Link ACC Network Termination

Once all Control Link ACCs are networked, you must terminate the end devices on the network.

#### 7.4.5.1 Termination Block Network

Because the Control Link ACC has no on-board means of termination, use the MODBUS termination block (P/N 535-2711) for termination that can be wired to the end of the cable segment using the three-pin connector. Wire the two signal wires to the outside terminals, and connect the shield to Earth Ground:

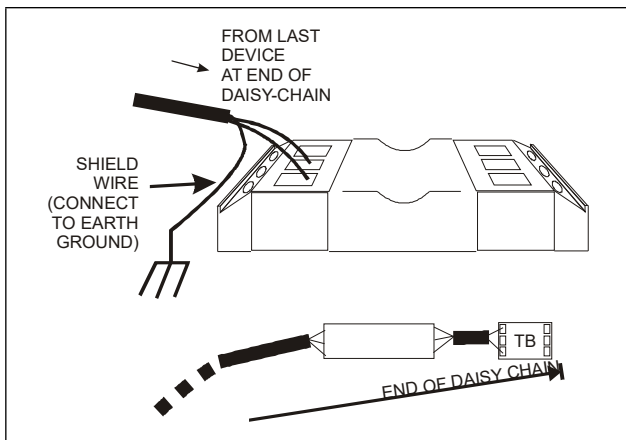

Figure 7-17 - MODBUS Termination Block

### 7.4.6 Step 6 - Connect a Dewpoint Sensor to Control Link ACC(s) on the Network

Once the Control Link ACCs are networked and properly terminated, the only step remaining to allow the Control Link ACCs to share a dewpoint sensor is to connect at least one dewpoint sensor to one Control Link ACC on the network. Any Control Link ACC on the network can be configured with the dewpoint sensor.

Each Control Link ACC first looks for a dewpoint sensor connected to itself. If a dewpoint sensor is directly connected to a Control Link ACC, it will use that sensor for its dewpoint value and broadcast the sensor's value on the MODBUS network. If no sensor is directly connected to a Control Link ACC, it will automatically look on the MODBUS network and use the sensor value broadcast by another Control Link ACC that has a sensor.

For fail-safe purposes, you may have multiple dewpoint sensors connected to different Control Link ACCs on the network. The Control Link ACCs automatically select a primary sensor to use, and will switch to another dewpoint sensor on the network if the primary sensor fails or is disconnected.

For dewpoint sensor wiring instructions, refer to Figure 6-3 and Figure 6-4.

### 7.4.7 Step 7: Set the Setpoint Temperature Offset

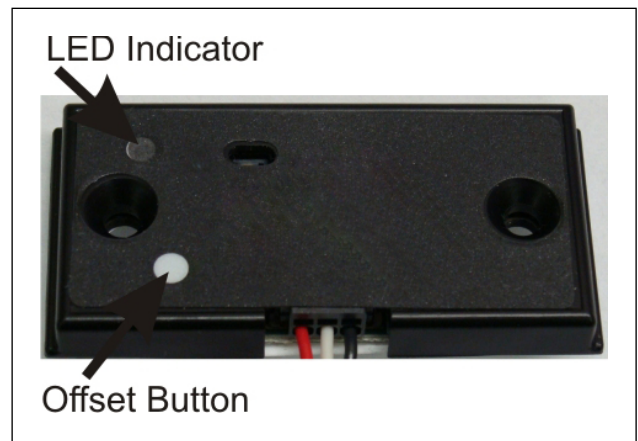

Figure 7-18 - Dewpoint Sensor Offset Button

The Control Link ACC seeks to maintain a constant minimum difference between the dewpoint of the outside air and the temperature of the door frame. You may specify how big this difference will be by pressing the temperature offset button on the dewpoint sensor.

The offset button on the dewpoint sensor is located on the lower left side of the sensor enclosure (see Figure 7-18), and the offset value is indicated by the LED in the upper left corner of the dewpoint enclosure. The LED will normally flash once every 4 seconds.

1. **Step 1:** Push and hold the offset button for 5 seconds to enter the configuration mode. (The LED will illuminate solid for 5 seconds prior to entering configuration mode. After 5 seconds it will turn off to indicate the dewpoint sensor has entered configuration mode.)
2. **Step 2:** Release the offset button and the LED will flash from 1 to 8 times depending on the current offset configuration. Each LED flash represents a 1-degree Celsius (1.8°F) incremental temperature offset. If the button is not pushed any further, after 10 seconds the unit will exit the configuration mode and will resume its normal operation and flash the LED once every 4 seconds. (Repeat **Step 1** to re-enter the configuration mode.)
3. **Step 3:** If the button is pushed within 10 seconds after the current setting is flashed, the offset value will increment by 1 degree Celsius (1.8°F) and the LED will flash the new offset value as one flash per degree Celsius of offset. For example, if the offset is set at 8°C (14.4°F), and the button is pushed to increment the value, the value will start over at the 1-degree Celsius offset (1.8°F).

## NOTE

If the offset button is pressed for more than 15 seconds, the LED will remain ON solid to indicate an offset button stuck condition, but the offset value will not be changed.

The offset button determines the number of degrees (in Celsius) that will be added to the value of the dewpoint sensor to determine the target temperature of the door frame. For example, if the current dewpoint is 5°C (41°F) and the button is set to a medium offset of 2°C (3.6°F), the Control Link ACC will control the heaters to achieve a door frame temperature of 7°C (44.6°F). As the dewpoint rises and falls, the door frame temperature setpoint will also rise and fall, so that the door frame temperature will always stay slightly above the current dewpoint.

The Control Link ACC uses the offset button on the dewpoint sensor to determine the value of the temperature offset. The Control Link ACC prioritizes them in the following ways:

1. If E2 is connected, the offset is configured at the E2.
2. If sharing a dewpoint sensor, the remote offset is provided even if the Control Link ACC has its own dewpoint sensor.
3. The local dewpoint sensor's offset is used.

This priority structure is designed to make it easier for temperature offsets to be changed in the field (by simply changing it on the dewpoint sensor), and it also allows multiple cases to use the same sensor while using different temperature offsets.

## TIP

Experiment with offsets to find the lowest possible setting that still offers good performance. In many cases, depending on the placement of the door frame temperature sensor, a LOW offset will still provide good anti-condensate performance. The lower the offset being used, the higher the energy savings.

## 7.4.8 Step 8 - Network Configuration Is Complete - Restore Power to the ACC

Restore power to the ACC and check the status of the network by observing the LEDs on the front of each Control Link ACC enclosure:

- If network communication is active, you should see the **RX** LED blinking at least once every 15 seconds. If you see no activity or a regular blinking pattern, there may be a problem with the MODBUS network wiring or configuration.
- For Control Link ACCs equipped with dewpoint sensors, you should see the **TX** LED blink to indicate transmission. If not, there may be a problem with MODBUS or dewpoint sensor wiring.
- For Control Link ACCs that do not have dewpoint sensors directly connected to them, verify the **Status** LED is blinking once every 2 seconds to indicate status is OK. If this LED blinks in a repeating pattern of three short blinks, it means the Control Link ACC is not receiving a dewpoint sensor value broadcast over the network. There may be a problem with the MODBUS or dewpoint sensor wiring.

# 8 The ACC Hand-Held Terminal Interface

## 8.1 HHT Hardware Overview

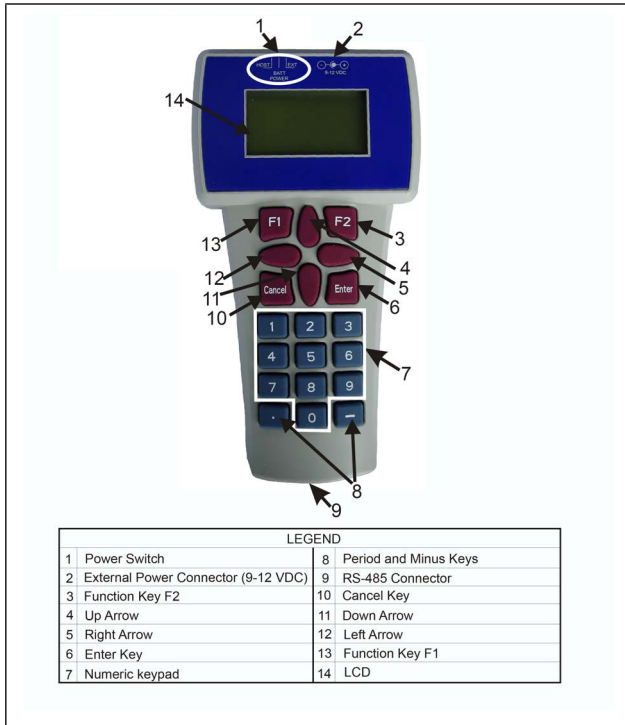

Figure 8-1 - Hand-Held Terminal

The power switch determines the power mode of the device, whether if self-powered (BATT), external powered (EXT), or powered by a target device (HOST).

The LCD screen can display up to 4 lines of characters (each line can hold 16 characters). It displays the home screen and the different menu screens of the HHT. The LCD serves also as a visual indicator that the HHT is functioning.

The RS-485 port supports the following:

- Standard dumb terminal mode protocol
- PL-430 version of I/O net
- I/O Net
- MODBUS

## 8.2 Keys and Functions

Table 8-1 - HHT Keys and Functions

Key	Functions
<b>F1 Key</b>	Returns you to the Home Screen.
<b>F2 Key</b>	Takes you to the Main Menu
<b>Enter</b>	Saves your settings into the memory
<b>Cancel</b>	Clears/Erases texts in the editable field; cancels overrides
<b>Left Arrow</b>	Selects the first editable field from top of screen, and the next editable field from top to bottom
<b>Right Arrow</b>	Selects the last editable field starting from the bottom of the screen; and the previous editable field from bottom to top
<b>Down Arrow</b>	Moves to the next screen, editable field, end of screen, or advances
<b>Up Arrow</b>	Go back to previous screen, editable field, or top of screen
<b>Period Key</b>	Scroll list selections and scroll through ASCII characters if in a text field
<b>Minus Key</b>	
<b>Number Keys (numbered 0-9)</b>	Choose a menu option or enter a value

## 8.3 Hand Held Terminal Expansion Board

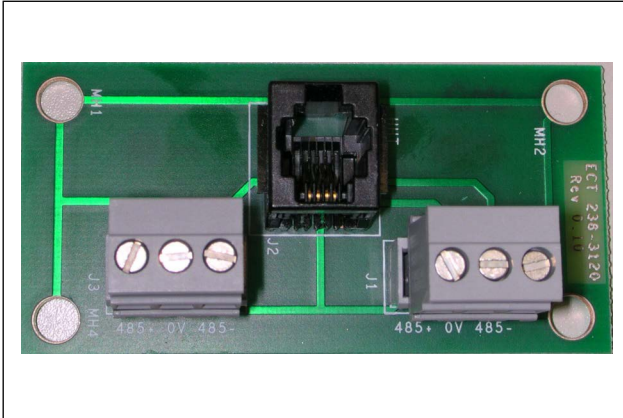

Figure 8-2 - Hand Held Terminal Expansion Board

With the 814-3112 Hand-Held Terminal and the 536-3120 Adapter Board, you can access the ACC via its MODBUS communication port without having to use the site controller. The Hand-Held Terminal interface allows you to perform these general functions:

- View failure messages that relate to the ACC
- View the status of inputs
- View the output percentage ON
- Override the outputs to a fixed percentage
- Make temporary or permanent changes to set points. If also connected to a site controller, any changes will be overwritten

An ACC HHT will also have these specific functions:

- It can issue a command to switch the MODBUS port into a dumb HHT port to view and set ACC information like a standard HHT
- It can be used to update firmware for the attached ACC

## 8.4 Connecting the HHT Adapter Board

The HHT Adapter Board is connected on the low voltage end of the ACC using a standard Belden 8761 cable (shown in Figure 8-3). The Hand-Held Terminal plugs into the RJ11 jack on the HHT Adapter Board. Press the Hand-Held Terminal connector into the jack until it snaps into place. When the connector is correctly seated, and the HHT is powered up in Battery or External Power Position the user will see the Home screen of the HHT.

### 8.4.1 HHT Home Screen

```
ECT HHT: <S/W>
          814 - 3112
          VER: 1.00F01-01
          (PRESS↓)
```

If the ACC is connected to an E2 network, the network connection needs to be removed.

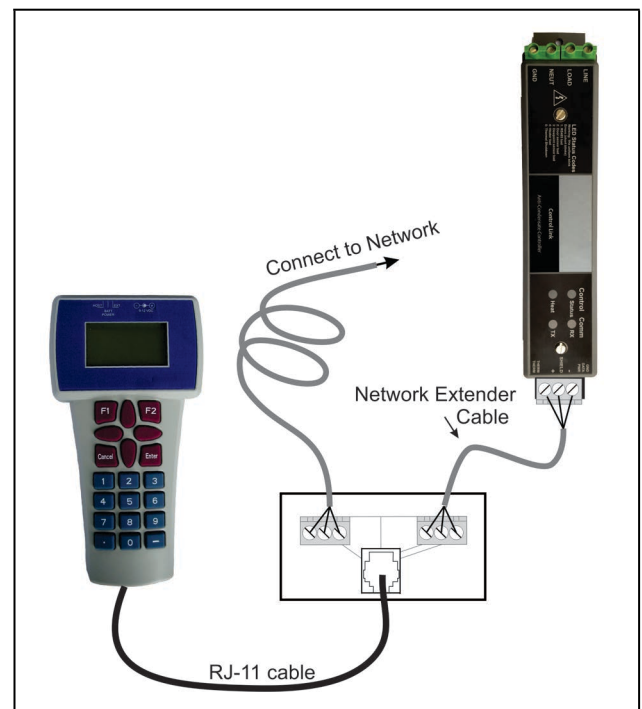

Figure 8-3 - HHT Adaptor Board Connection to the ACC

## 8.5 HHT Interface Navigation

The Hand-Held Terminal interface consists of a simple series of screens and menus.

### 8.5.1 Scrolling Through The Hand-Held Screens

The up arrow and down arrow keys are used to scroll through the screens. Some of these screens are read-only, others are either menus that require you to enter a selection or are configuration screens that have one or more editable fields. The right arrow and left arrow are used to select editable fields.

### 8.5.2 Shortcut Keys (F1 and F2)

At any time, you may press the F1 key on the Hand-Held Terminal to return to the Home Screen, or F2 to view the first status screen.

### 8.5.3 ACC HHT Network Setup

When the ACC is connected to the HHT for the first time using the HHT protocol, the Network Setup menu will be displayed.

```
SELECT
1= SLAVE TERMINAL
2= ACC HHT MODE
3= UPGRADE ACC FW
```

**SLAVE TERMINAL:** Returns the HHT into a mode controlled by the host.

**ACC HHT MODE:** Enter the mode where the MODBUS port runs the standard HHT dumb terminal protocol.

**UPGRADE ACC FW:** Upgrade the firmware of an ACC to the version loaded on the HHT.

#### NOTE

Press F1 for approximately 6 seconds to return to this screen at any time.

#### 8.5.3.1 Modes of ACC Addressing

The ACC can be addressed in two different ways, via the dip switch on the unit or by using the HHT to set the address over MODBUS. If you are setting the address with the HHT, all the dip switches must be set to 0 or OFF, and you must be directly connected to the HHT **ONE-ON-ONE** connection type (no other nodes connected to the network). See **Section 8.5.8** for details.

If setting the address via the dip switches, set the address to match the dip switch numbering in the HHT Network Setup Screen (**ADDR: 1**).

Selecting option 2 (**ACC HHT MODE**) will lead you to the Network Setup screen.

```
ACC SETUP
BAUD   : 19200
PARITY : NONE
ADDR   : 1
```

The network screen will display the baud rate, address, and parity selection. A baud rate of 19200 is recommended, set the parity to **NONE**, and choose the address of the ACC unit you need to access. A message will then appear:

```
WAITING CONNECT
TO MASTER CNTRL
```

Once you are in the ACC HHT mode, it will display the ACC home screen (see **Section 8.5.4**).

To leave ACC HHT mode to access another ACC, press F1 for approximately 6 seconds. You will see the Home Screen for the HHT shown at the start of **Section 8.4**

### 8.5.4 The ACC HHT Interface

#### 8.5.4.1 ACC Start Screens

```
CONTROL LINK ACC
      815 - 6100
VER: 1.00F01-01
(PRESS↓)
```

After finishing the initial setup, the HHT display will show the model type, the part number, and the firmware revision.

The fourth line of the home screen will flash and display failure information if the HHT detects an internal or communication problem after its power-up. If more than one failure exists, information will be displayed according to the following priority order:

- **FAIL: FLASH/CLK:** The flash memory on the micro is corrupted, and/or the crystal clock is not functioning properly
- **FAIL: DEWPT SNS:** The ACC does not have a valid dewpoint sensor reading.
- **FAIL: TEMP SNS:** The door frame temp sensor is not functioning properly.
- **FAIL: OVER TEMP:** The output heater is turned off because the driver is overheating.

## 8.5.5 ACC Status Screens

The two ACC Status Screens show the current readings of all ACC inputs, the Relative Humidity, the Ambient Temperature, the Dewpoint and the Door Temperature, and other operating information.

### 8.5.5.1 Input Status Screen

```
DOOR TMP: 12.6
DOOR STPT: 13.0
ROOM DP: 32.0
TMP: 75 RH: 50
```

- **DOOR TMP:** The current value from the door frame temperature sensor. The statuses OPEN or SHORT mean the sensor is not functioning properly.
- **DOOR STPT:** The current value of the door frame temperature setpoint.
- **ROOM DP:** The current value of the room dewpoint sensor. NONE means the ACC has not received a valid dewpoint reading.
- **TMP:** The current value of the ambient temperature. NONE means the ACC has not received an ambient temperature reading. The ACC bases control on the dewpoint sensor so this is not critical.
- **RH:** The relative humidity. NONE means the ACC has not received a relative humidity reading. The ACC bases control on the dewpoint sensor so this is not critical.

### 8.5.5.2 Output Status Screen

```
DUTY CYCLE%: 34
OVR: NO %: 00
OVR SRC: HHT
SAVINGS%: 62
```

- **DUTY CYCLE%:** The current output condition.
- **OVR and %:** Active heater output override (YES or NO) and percentage.
- **OVR SRC:** Source of the current override (HHT or REMOTE).

#### NOTE

The HHT will be able to override an override that was initiated remotely. The user will be able to override the heater output to a fixed percentage. Once the HHT is removed, the override will end.

- **SAVINGS%:** The percentage of time the heater has been off. This field may be reset by selecting it and pressing cancel.

## 8.5.6 ACC Configuration Screens

All of the configuration of the ACC may be changed using the HHT. HHT users may change setpoints and overrides.

### 8.5.6.1 HHT Changes When ACC is Connected to E2

All changes to setpoints made by the HHT are temporary if the ACC is connected to a parent E2. Changes made in the HHT do not change the configuration stored in the E2. When the HHT is unplugged from the ACC, all changes made by the HHT are overwritten by the E2, including output overrides. If you wish to make permanent changes to the ACC's configuration, you must make them through the E2 (or through a remote communication program connected to the E2, such as UltraSite32).

### 8.5.6.2 HHT Changes When ACC is Stand-Alone

If the ACC is operating standalone with no connection to an E2, the HHT is the only method that may be used to change configuration. When the HHT is unplugged from the ACC, all changes to configuration will be saved. Overrides made with the HHT, however, will be canceled when the HHT is unplugged.

### 8.5.6.3 The Main Selection Screen

```
SELECT: ___ 1
1: NETWORK
2: TEMP OFFSET
3: CTRL OPTIONS
```

Press down arrow past the Status Screen to access the Main Selection screen. To select, press the right arrow key, enter the number of the sub-menu you wish to access, then press down arrow key twice to access the sub-menu's first screen.

- **Network** - General info about the ACC network and dewpoint sensor attached.
- **Temperature Offset** - Setpoints that determine the operation of the ACC.
- **Ctrl Options** - Where PID parameters are selected



## Network

```
ACC SETUP
BAUD   : 19200
PARITY : NONE
ADDR   : 1
```

The network screen will display the baud rate, address, and parity selection.

```
DEW POINT SENSOR
STATE: ONLINE
VER: 1.00F01
```

If the dewpoint sensor is connected, a screen will display the state (ONLINE or OFFLINE) and the firmware version of the sensor.

## Temperature Offset Screen

The source of the set point offset can be selected on the temperature offset screen. The set point offset is added to the dew point to determine the setpoint for door temperature.

```
CONTROL LOOP:
MODE: CLOSED

BoardTemp: 77.3
```

Board temperature will shutdown the output heater if greater than 212°F (100°C)

Two modes can be selected for the temperature offset, Closed Loop, and Open Loop.

## Closed Loop

```
OFFSET SRC: REM
ACT OFFSET: 1.0
PRG OFFSET: 2.0
CYCLE TIME: 0
```

Closed Loop is the default that uses the Door Temperature feedback.

**OFFSET SRC:** Specifies the source of the set point offset:

- **REM** - Remote means it takes the offset reported over ModBus network.
- **PRG** - Program means it uses the offset configured as part of the user configuration.
- **LOC** - Local means it uses the offset set for the local dew point sensor.

**ACT OFFSET:** Active temperature offset.

**PRG OFFSET:** Programmed temperature offset.

**CYCLE TIME:** Set from 0 to 30 seconds (recommended setting). If the Cycle Time is 0 then the controller will work in an instantaneous mode where the output is updated every 0.1 seconds. Leave the value to 0 for the greatest energy savings.

## Open Loop

```
100%DewPT: 65
0%DewPT: 25
CYCLE TIME: 10
```

**100%DewPT:** Temperature offset at 100%.

**0%DewPT:** Temperature offset at 0%.

**CYCLE TIME:** Set from 0 to 30 seconds. For an Open Loop operation, 10 seconds is recommended.

## Control Options Screen

```
PI PARAMETERS
P: 2.0
I: 0.10
TEMP: FAHRENHEIT
```

The PID Parameters have been set to default values 2.00 and 0.10. These values should not need to be changed.

**TEMP:** Used to set the HHT display option. All temperatures are in degrees Celsius internally, but when TEMP is set to Fahrenheit (default) they are displayed as Fahrenheit.

## **8.5.7 Upgrading ACC Using HHT**

Return to the main HHT screen by pressing **F1** for approximately 6 seconds (if you are talking to an ACC and in the ACC mode)

```
SELECT
1= SLAVE TERMINAL
2= ACC HHT MODE
3= UPGRADE ACC FW
```

Select **3** for upgrade firmware and a new screen will appear:

```
CONROLLINK ACC
VER: 3.10B006
SLOT: 1 CNT: 0
UPGRADE: NO
```

Use the right/left arrow to see the arrow appear next to **NO** (default). Press the - (dash) button to toggle to **YES**.

```
ACC SETUP:
BAUD: 19200
PARITY: NONE
ADDR: 1
```

Select the address of the ACC to upgrade.

Press the down arrow to start the upgrade. The Block number will update as blocks are sent to the ACC.

If the upgrade was successful this screen will display:

```
UPGRADE RESULT:

FIRMWARE UPDATED
```

Press the down arrow to go to the Menu screen.

## 8.5.8 Changing ACC Address Using HHT

If you are setting the address of the ACC with the HHT, you must be connected directly to one and only one ACC. From the Home screen, choose 2 (ACC HHT mode), choose the address, and press down arrow. (The user can also set the baud and parity, 19200 and no parity is recommended)

```
ACC SETUP:
BAUD: 19200
PARITY: NONE
ADDR: 1
```

Pressing the down arrow may show you the next screen if the HHT doesn't find an ACC at that selected address.

```
ONE-ON-ONE?
NEED TO SET NODE
BAUD AND PARITY.
PROCEED?: NO
```

The HHT will ask if you are connected to the ACC that you wish to communicate with directly; the user has to be connected directly to set the address of an ACC. Press the left or right arrow keys to display the arrow next to the **NO** (default). Press the - (dash) key to toggle it to **YES**.

Once the address (and/or baud and parity) is changed, you will be connected in ACC HHT mode and you will see the ACC Home Screen. See **Section 8.5.4** for more details.

### NOTE

If the address is already pre-set on the ACC using the dip switches, the address cannot be changed with the HHT. The pre-set dip switches on the ACC will always take priority.

## 8.5.9 Exit HHT Mode

To exit a current mode on the HHT, unplug and reconnect (cycle power) or press down the F1 key for 6 seconds. This will return you to the HHT home screen where you can access the **ACC-HHT Mode** option. Select the address of the ACC you wish to access.

## 9 Operation

The Control Link ACC uses two algorithms for modes of operation. For the standard mode of operation, the Control Link ACC prevents moisture accumulation by maintaining door frame temperature based on the dewpoint and setpoint offset. The alternate PMAC mode of operation can be configured from the E2 and is also used under failure conditions if no door frame temperature sensor is available. Using the PMAC algorithm, the Control Link ACC will calculate the heater ON time based on the dewpoint temperature. The configuration has two parameters: the first sets the lower dewpoint temperature at which the heater will be OFF. The second sets the upper dewpoint temperature at which the heater will be 100% ON. A linear calculation is made between those limits:

$$\text{Heater ON\%} = \frac{100\% * (\text{Current Dewpt} - \text{DewptOFF})}{(\text{DewptON} - \text{DewptOFF})}$$

The ACC monitors a board temperature near the heater output driver to ensure that the heater driver does not exceed its maximum temperature rating. There is a back-off algorithm that will become active once the monitored board temperature says the heater driver is within 6°C (10.8°F) of the maximum temperature rating. At 6°C (10.8°F) below the maximum rating, the ACC will not let the heater driver be ON more than 95% of the time. If the temperature continues to rise and is within 3°C (5.4°F) of the maximum rating of the heater driver, the algorithm will not let the heater driver be ON more than 90% of the time. The final step is triggered if the heater driver is more than 2°C above its maximum rating at which time the heater will be turned OFF. This is the OVER TEMP failure condition (see **Section 10, Error Modes**). Once the heat driver temperature drops 5°C (9°F) it will be allowed to come back ON.

This back-off strategy will only come into affect if the heater has to be ON 100%, you are running at the maximum rated current, you are at maximum rated ambient for the ACC.

### 9.1 Control Link ACC Status LEDs

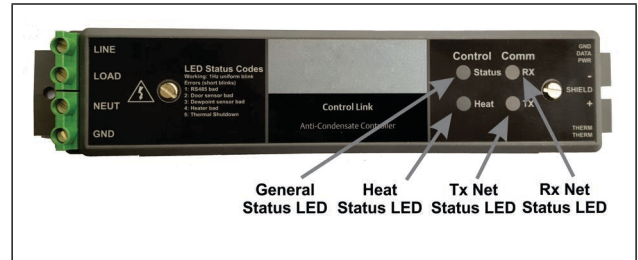

Figure 9-1 - LED Locations

The Control Link ACC has four status LEDs that indicate what the controller is doing. They are: the red Heater Status LED (HEAT), the green General Status LED (Status) and the two Network Status LEDs (red transmit TX and yellow receive RX).

#### 9.1.1 Heater Status LED

The Heater Status LED (**Heat**) glows red any time the door heaters are ON, and is OFF when the heaters are OFF.

Under normal operation, this LED should pulse ON and OFF when no door sweat is visible, indicating it is pulsing the heaters to maintain the necessary amount of heat to prevent door sweating (given the current dewpoint and case temperature). When a case door is opened, the LED will remain ON for longer periods of time (and may even remain ON without pulsing) to compensate for the change in case door frame temperature.

Note that it is possible for this LED to remain OFF for long periods of time if the dewpoint is very low (e.g., during dry winter days).

#### 9.1.2 General Status LED

The General **Status** LED blinks green to indicate the controller is powered up and functioning normally, and whether or not there are any alarm conditions.

If the controller is functioning normally, the **Status** LED will blink once per second. If there is an error condition, it will blink at different rates to indicate the active error condition (see **Section 10, Error Modes**).

#### 9.1.3 TX and RX Status LEDs

If the Control Link ACC is being networked with other Control Link ACCs via its MODBUS network connection, the **TX** and **RX** LEDs blink to indicate transmission and receipt of network messages. On a properly networked Control Link ACC, the **RX** LED should blink about once every 15 seconds. If a Control Link ACC has a dewpoint sensor, you should also see the **TX** LED blink. If these LEDs do not blink, there may be a problem with the MODBUS network connection.

## 10 Error Modes

The Control Link ACC has several error modes it will enter when failures occur. The controller has a General **Status** LED that blinks at a 0.5 Hz (1 blink per second) rate if the microprocessor is running. If any of the error modes below occur, the green **Status** LED will blink at a rate specific to the error condition. The controller has a **Heat** LED that illuminates when the heater is on. In the case of an error condition, the heater will go into the indicated mode. For each error mode, note the priority level — if more than one error mode is active, the LED blink rate will only show the error condition with the highest priority (priority #1 is the highest, and priority #5 is the lowest). Note that a higher priority will mask a lower priority error until the higher priority is fixed.

### 10.1 Priority 1: FAIL: OVER TEMP

The board temperature sensor has determined that the heater driver is exceeding its maximum temperature rating. If this condition is detected, the heater output will be turned OFF. Once the temperature has fallen at least 5°C (9°F), the heater will be allowed to come back ON. General Status LED blinks 5 times: pause - 5 times - pause, and then repeats.

### 10.2 Priority 2: FAIL: TEMP SENS

If the PMAC Algorithm mode is NOT enabled, a door frame temperature sensor that is open or shorted is considered to be a failure. The General Status LED blinks 2 times: pause - 2 times - pause, and then repeats. If the PMAC Algorithm is enabled, the General Status LED will continue to blink normally even if the door frame temperature sensor is not present. If the door frame temperature sensor is not present, the Control Link ACC will revert to PMAC mode for operation.

### 10.3 Priority 3: FAIL: DEWPT SNS

Cannot communicate with the dewpoint sensor, and there is no dewpoint data being broadcast. The ACC will attempt for a duration of 100 seconds to communicate with a local dewpoint Sensor before flagging this failure. Once past the first 100 seconds, the remote timeout is 46 seconds before this error will occur. If there is no dewpoint sensor, the heater will be on 95% of the time. The General Status LED blinks 3 times: pause - 3 times - pause, and then repeats.

### 10.4 Priority 4: FAIL: FLASH/CLK

Either the Flash executable code has changed or the hardware clock is not functioning properly. The General **Status** LED blinks: short - long - pause, and then repeats.

### 10.5 Priority 5: FAIL: CONFIGURE

The user configuration has an error in the version stored in flash. The General Status LED blinks: long - short -pause, and then repeats.

# 11 Troubleshooting Control Link ACCs and the MODBUS Network

## 11.1 If Control Link ACC is Offline

- Check wiring** - Verify the Control Link ACC is properly connected to the MODBUS cable. Verify the network polarity is correct (+ to +, - to -, 0V to 0V) and there are no loose wires. If none of the Control Link ACCs are online, check wiring connections on the E2. Check the cable jackets to make sure all network cable is Belden #8761 or equivalent.
- Verify MODBUS Port Setup** - Press **Alt** + **M** on the E2 front panel. Verify COM2, COM4, or COM6 is set up as a MODBUS port. If so, verify that the MODBUS cable is connected to the proper connectors (refer to **Figure 7-1** on page 9). Verify the COM port fields are properly set for MODBUS (19.2k baud, data size=8 bits, Parity=NONE, stop bits=1).
- Make sure Control Link ACCs were commissioned** - Press **Menu** followed by **&7 &7 #** on the E2 front panel and verify the offline Control Link module has a non-zero number in its **Node/Board#** field. If the number in the **Node/Board#** field is zero (0), highlight the controller name and select **F4** - SET ADDRESS followed by **1** - Select Address. Then select the network ID that matches the setting on the network address DIP switch/jumper.
- Check Control Link ACC network card DIP switch/jumper settings** - make sure switches/jumpers 1-6 on the Control Link ACC network card match the network ID number of the offline Control Link ACC.
- Verify switches/jumpers 7 and 8 are in the DOWN position** - Switches/jumpers 7 and 8 in the DOWN position specify 19.2k baud and no parity. If either of these switches/jumpers are not in the DOWN position, set them DOWN.
- Check network termination** - The two devices on either end of the MODBUS network should be terminated, with all other devices in the daisy chain unterminated. Check termination settings for all devices on the network.

## 12 Specifications

Table 12-1 - Control Link ACC Specifications

<b>Temperature Range</b>	Storage Temp: -40°F to 149°F (-40°C to 65°C)
<b>Ambient Operating Temperatures (UL Listed) P/N 815-6100</b>	-40°F to 104°F (-40°C to +40°C) up to 10A (indoor, freestanding with no additional heat sink) -40°F to 149°F (-40°C to +65°C) up to 7A (indoor, freestanding with no additional heat sink)
<b>Ambient Operating Temperatures (UL Recognized) P/N 815-6105</b>	-40°F to 77°F (-40°C to +25°C) up to 30A (with additional heat sink with max thermal resistance of 0.92°F/Watt (0.51°C/Watt) -40°F to 104°F (-40°C to +40°C) up to 26A (with additional heat sink with max thermal resistance of 0.92°F/Watt (0.51°C/Watt) -40°F to 149°F (-40°C to +65°C) up to 18A (with additional heat sink with max thermal resistance of 0.92°F/Watt (0.51°C/Watt)
<b>Input Voltage</b>	120/240 Nominal (102VAC to 264VAC) 50/60 Hz
<b>Humidity</b>	5% to 95% non-condensing
<b>Door Frame Temp Sensor</b>	+/- .72°F of 32°F to 176°F (+/- 0.4°C of 0 to 80°C) up to +/- 1.08°F at -40°F and 248°F (+/- 0.6°C at -40°C and 120°C)
<b>Dewpoint Sensor</b>	+/- 1.8°F (+/- 1°C) over RH of 40 to 95% RH +/- 7.2°F (+/- 4°C) over RH of 10 to 40% RH
<b>Agency Approvals</b>	UL916 Open Energy Management Equipment, File E118489, FCC Part 15 Class A (non-intentional radiators), CE, RoHS

## 13 Part Numbers and Descriptions

Table 13-1 - Control Link ACC Part Numbers and Descriptions

Part Number	Item Description
<b>815-6100</b>	Control Link ACC 10Amp UL Listed
<b>815-6105</b>	Control Link ACC 30Amp UL Recognized
<b>281-0002</b>	Door Frame Temperature Sensor
<b>814-6115</b>	Dewpoint Sensor
<b>281-0001</b>	Door Frame Temperature Sensor (included with ACC Kits 1-4 listed below)
<b>815-6101</b>	ACC Kit (1) - Control Link ACC 10Amp and Door Frame Temp Sensor
<b>815-6106</b>	ACC Kit (2) - Control Link ACC 30Amp and Door Frame Temp Sensor
<b>815-6102</b>	ACC Kit (3) - Control Link ACC 10Amp, Door Frame Temp Sensor and Dewpoint Sensor
<b>815-6107</b>	ACC Kit (4) - Control Link ACC 30Amp, Door Frame Temp Sensor and Dewpoint Sensor

*For more product information,  
scan the QR Code:*



Visit our website at [copeland.com/en-us/products/controls-monitoring-systems](https://copeland.com/en-us/products/controls-monitoring-systems) for the latest technical documentation and updates.  
For Technical Support call **833-409-7505** or email [ColdChain.TechnicalServices@Copeland.com](mailto:ColdChain.TechnicalServices@Copeland.com)

The contents of this publication are presented for informational purposes only and they are not to be construed as warranties or guarantees, express or implied, regarding the products or services described herein or their use or applicability. Copeland reserves the right to modify the designs or specifications of such products at any time without notice. Responsibility for proper selection, use and maintenance of any product remains solely with the purchaser and end-user.  
©2024 Copeland is a trademark of Copeland LP.